

IP2371EN • 2022-03-17

Ditec LCA85

Control panel installation manual for automations with one 230 V~ motor

(translation of the original instructions)

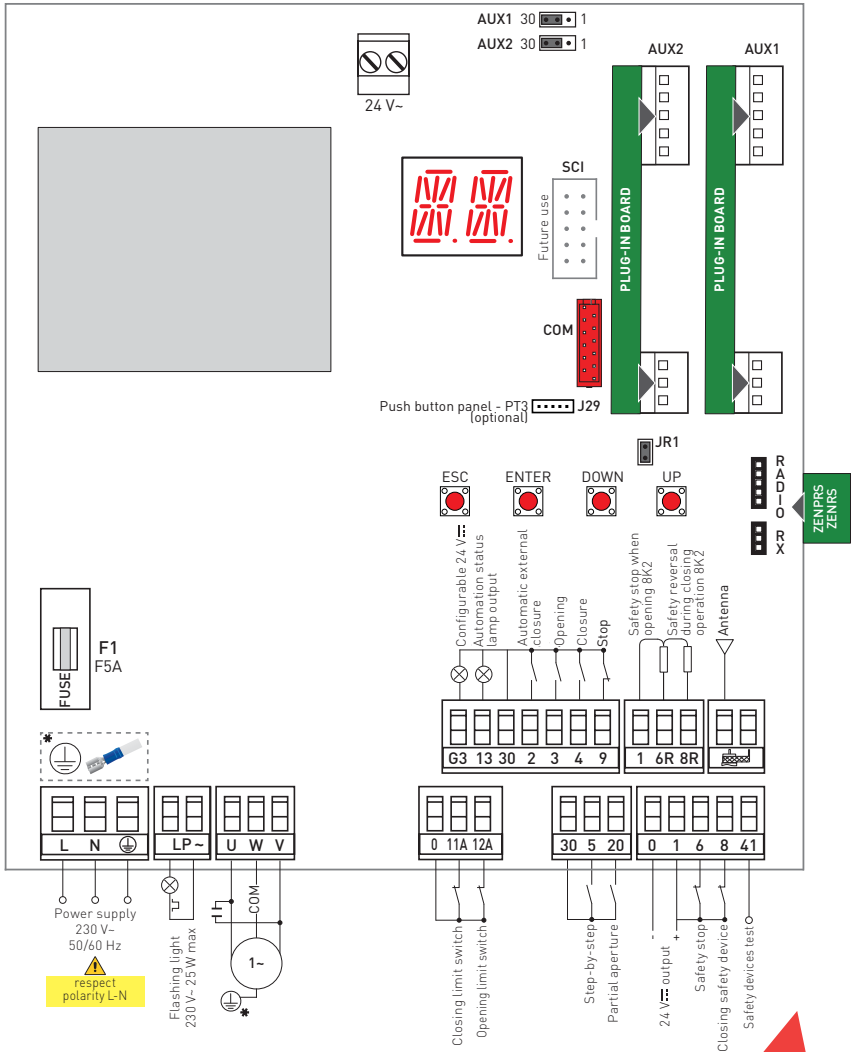

Contents

General safety precautions for the user	3
General safety precautions for technical personnel	5
EC Declaration of Conformity	7
1. Safety functions	8
2. Technical specifications	8
2.1 Applications	8
3. Installation and electrical connections	9
3.1 CROSS installation	11
3.1.1 Standard installation	11
3.1.2 Wiring diagram	12
3.2 DOD14 installation or sectional door automations 230 V-	13
3.2.1 Standard installation	13
3.2.2 Wiring diagram	14
3.3 Standard installation 230 V- barrier	15
3.3.1 Ditec QIK4E standard installation wiring diagram	15
4. Commands and safety devices	16
4.1 Command inputs	16
4.2 Safety inputs	16
4.3 Limit switch inputs	17
5. Outputs and accessories	17
6. Jumper setting	18
7. Using menus	19
7.1 Switching the display ON and OFF	19
7.2 Navigation keys	19
7.3 Menu map	20
8. Setting up product for first use	22
8.1 Wizard configuration menu (WZ)	22
8.2 Basic start-up example	24
8.2.1 Sliding gate	24
8.2.2 Barrier	24
8.2.3 Sectional door	25
8.3 Frequently used menu sequences	26
8.3.1 Enabling the configurations	26
8.3.2 Adding remote controls	26
8.3.3 Configuring the NC contact safety devices	26
8.3.4 Configuring the resistive safety edges	26
8.4 Synthetic diagram of operation	27
9. Configuration and settings menu	28
9.1 Main menu	28
9.2 Second level menu - AT (Automatic Configuration)	29
9.3 Second level menu - BC (Basic settings)	30
9.3.1 Additional configurable BC level parameters available with AT → AA enabled	31
9.4 Second level menu - BA (Basic adjustments)	31
9.4.1 Additional BA level parameters that can be configured (available with AT → AA enabled)	34
9.5 Second level menu - RO (Radio operations)	36
9.5.1 Additional configurable BO level parameters available with AT → AA enabled	37
9.6 Second level menu - SF (Special Functions)	38
9.6.1 Additional configurable SF level parameters available with AT → AA enabled	39
9.7 Second level menu - CC (Cycles Counter)	40
9.7.1 Additional configurable CC level parameters available with AT → AA enabled	40
9.8 Second level menu - EM (Energy management)	40
9.9 Second level menu - AP (Advanced parameters)	41
9.9.1 Additional configurable AP level parameters available with AT → AA enabled	42
10. Diagnostics	45
10.1 Data Logging integrated in the board	45
10.1.1 Alarm counter	45
10.1.2 Alarm log	45
11. Signals visualised on the display	45
11.1 Display of automation status	45
11.2 Display of safety devices and commands	46
11.3 Visualisation of alarms and faults	47
12. Troubleshooting	49
13. Maintenance	50

Key



This symbol indicates instructions or notes regarding safety, to which special attention must be paid.



This symbol indicates useful information for the correct operation of the product.

Factory settings

General safety precautions for the user



ATTENTION! Important safety instructions.

Please follow these instructions carefully. Failure to observe the information given in this manual may lead to severe personal injury or damage to the equipment.

Keep these instructions for future reference.

WARNING! Disconnect power supply before any cleaning or maintenance operation.

This manual and those for any accessories can be downloaded from www.ditecautomations.com.

These precautions are an integral and essential part of the product and must be supplied to the user. Read them carefully since they contain important information on safe installation, use and maintenance. These instructions must be kept and forwarded to all possible future users of the system • This product must be used only for the specific purpose for which it was designed. Any other use is to be considered improper and therefore dangerous. The manufacturer cannot be held responsible for any damage caused by improper, incorrect or unreasonable use • Avoid operating in the proximity of the hinges or moving mechanical parts. Do not enter within the operating range of the motorized door or gate while it is moving. Do not obstruct the motion of the motorized door or gate, as this may cause a dangerous situation • Lock and release the door or gate wings only when the motor is switched off. Do not enter within the action range of the door or gate wing(s) • In case of operation in “hold-to-run” (“dead man”) mode, the corresponding command devices must be located so to have direct and complete view of the door or gate during the maneuvers, away from any moving parts, at a minimum height of 1.5 m, and out of reach of the public • The motorized door or gate may be used by children over the age of 8 and by people with reduced physical, sensorial or mental abilities, or lack of experience or knowledge, as long as they are properly supervised or

have been instructed in the safe use of the device and the relative hazards

- Children must be supervised to make sure they do not play with the device, nor play or remain in the area of action of the motorized door or gate. Keep remote controls and/or any other command devices out of the reach of children, to avoid any accidental activation of the motorized door or gate
- Cleaning and maintenance work intended to be done by the end user must not be carried out by children unless they are supervised. In the event of a product fault or malfunction, turn off the power supply switch. Do not attempt to repair or intervene directly. Any repair or technical intervention must be carried out by qualified personnel. Failure to comply with the above may cause a dangerous situation. To ensure that the system works efficiently and correctly, the manufacturer's indications must be complied with and only qualified personnel must perform routine maintenance on the motorized door or gate. In particular, regular checks are recommended in order to verify that the safety devices are operating correctly
- All installation, maintenance and repair work must be documented and made available to the user
- To correctly dispose of electrical and electronic equipment, of batteries, and of accumulators, users must take the product to special "recycling centers" provided by the municipal authorities.

General safety precautions for technical personnel



ATTENTION! Important safety instructions.

Please follow these instructions carefully. Failure to observe the information given in this manual may lead to severe personal injury or damage to the equipment.

Keep these instructions for future reference.

This manual and those for any accessories can be downloaded from www.ditecautomations.com.

This installation manual is intended for qualified personnel only • Installation, electrical connections and adjustments must be performed by qualified personnel, in accordance with Good Working Methods and in compliance with the current regulations • Read the instructions carefully before installing the product. Wrong installation could be dangerous • Before installing the product, make sure it is in perfect condition •



The packaging materials (plastic, polystyrene, etc.) should not be discarded in the environment or left within reach of children, as they are a potential source of danger • Do not install the product in explosive areas and atmospheres: the presence of inflammable gas or fumes represents a serious safety hazard • Make sure that the temperature range indicated in the technical specifications is compatible with the installation site • Before installing the motorization device, make sure that the existing structure, as well as all the support and guide elements, are up to standards in terms of strength and stability. Verify the stability and smooth mobility of the guided part, and make sure that no risks of fall or derailment subsist. Make all the necessary structural modifications to create safety clearance and to guard or isolate all the crushing, shearing, trapping and general hazardous areas • The motorization device manufacturer is not responsible for failure to observe Good Working Methods when building the frames to be motorized, or for any deformation during use • The safety devices (photocells, safety edges, emergency stops, etc.) must be installed taking into account the applicable laws and directives, Good Working Methods, installation premises, system operating logic and the forces developed by the

motorized door or gate • The safety devices must protect against crushing, cutting, trapping and general danger areas of the motorized door or gate. Display the signs required by law to identify hazardous areas. Each installation must bear a visible indication of the data identifying the motorized door or gate • Before connecting the power supply, make sure the plate data correspond to those of the mains power supply. An omnipolar disconnection switch with a contact opening distance of at least 3mm must be fitted on the mains supply. Check that there is an adequate residual current circuit breaker and a suitable overcurrent cutout upstream of the electrical installation in accordance with Good Working Methods and with the laws in force • When requested, connect the motorized door or gate to an effective earthing system that complies with the current safety standards • Before commissioning the installation to the end user, make sure that the automation is adequately adjusted in order to satisfy all the functional and safety requirements, and that all the command, safety, and manual release devices operate correctly.



During installation, maintenance and repair operations, cut off the power supply before opening the cover to access the electrical parts • The protection cover of the operator must be removed by qualified personnel only.



The electronic parts must be handled using earthed anti-static conductive arms. The manufacturer of the motorization declines all responsibility if component parts not compatible with safe and correct operation are fitted • Only use original spare parts for repairing or replacing products • The installer must supply all information concerning the automatic, manual and emergency operation of the motorized door or gate, and must provide the user with the operation and safety instructions.

EC Declaration of Conformity

We:

ASSA ABLOY Entrance Systems AB
Lodjursgatan 10
SE-261 44 Landskrona
Sweden

Declare under our sole responsibility that the types of equipment with names:

Dltec LCA85 Control unit for 230 V~ sliding gate and barrier operators
Ditec LCA85B Control unit for 230 V~ industrial sectional door operators

Comply with the following directives and their amendments:

2014/35/EU Low Voltage Directive (LDV)
2014/30/EU Electromagnetic Compatibility Directive (EMCD)
2011/65/EU Restriction of hazardous substances (RoHS 2)
2015/863/EU Restriction of hazardous substances (RoHS 2 Amendment)

Harmonized European standards that have been applied:

EN 61000-6-3:2007 + A1:2011 + AC:2012
EN 61000-6-2:2019
EN 60335-1:2012 + AC:2014 + A11:2014 + A13:2017 + A1:2019 + A14:2019 + A2:2019
EN 60529:1991 + A1:2000 + A2:2013 + AC:2016
EN 62233:2008 + AC:2008
EN ISO 13849-1:2015

Other standards or technical specifications that have been applied:

IEC 60335-1:2010 + C1:2010 + C2:2011 + A2:2013 + C1:2014 + A2:2016 + C1:2016
EN 12453:2017

The manufacturing process ensures the compliance of the equipment with the technical file.

Responsible for technical file:

Matteo Fino
BSP Ind channel & Gate Automation
Ditec S.p.A.
Largo U. Boccioni, 1
21040 Origgio (VA)
Italy

Signed for and on behalf of ASSA ABLOY Entrance Systems AB by:

Place	Date	Signature	Position
Origgio	2022-03-17	Matteo Fino	Head of Ind channel & Gate Automation



1. Safety functions

The Ditec LCA85 control panel has the following safety functions:



- obstacle recognition with force limiting.

The maximum response time of the safety functions is 0.5 s. The reaction time to a faulty safety function is 0.5 s. The safety functions comply with the standards and performance level indicated below:

EN ISO 13849-1:2015 Category 2 PL=c

The safety function cannot be bypassed either temporarily or automatically. Fault exclusion has not been applied.

2. Technical specifications

Power supply	230 V~ ±10%, 50/60 Hz	
Power absorption	4.2 A max	
Fuses	F1= F5A (Motor driver circuits)	
Motor output	230 V~ 50/60 Hz; 1 x 4 A max	
Permanent power supply to accessories 0-30	24 V $\overline{\text{=}}$ 0.3 A max	 WARNING: the total sum of the current values delivered by 30,1 and 24 V~ outputs must never exceed 0.5 A
Power supply to accessories 0-1	24 V $\overline{\text{=}}$ 0.3 A max	
24 V~ accessory power supply	24 V~ 0.3 A max	
230 V~ flashing light output	25 W max	
Ambient temperature	 -20 °C - +55 °C	
Remote controls	100/200 [see RO → MU → 10/20]	
Radio frequency	433.92 MHz (prod. code ZENRS) or 868.35 MHz (prod. code ZENPRS)	
		The receiver module is purchasable separately.
Degree of protection of the housing	IP55	
Product size	LCA85: 187x261x103 mm LCA85B: 238x357x120 mm	

 **NOTE:** The given operating and performance features can only be guaranteed with the use of DITEC accessories and safety devices.

2.1 Applications

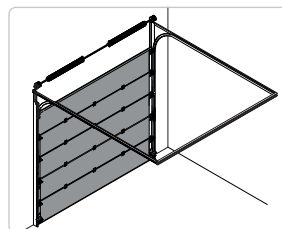
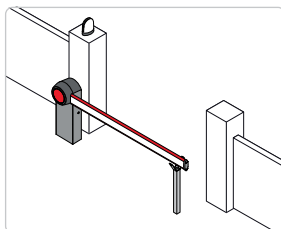
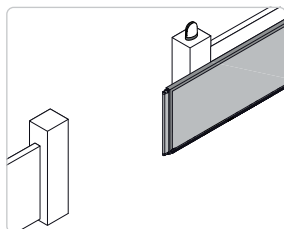

3. Installation and electrical connections

- For wall-mounted control unit:
 - Perforate the relevant points in the bottom part of the box (Fig. 3.1 - only for wall installation).
 - Fix the control panel firmly in place. You are advised to use convex head screws (max head $\varnothing 10$ mm) with a cross imprint (the centre distance for the holes is shown in Fig. 3.2 - only for wall installation).
 - Insert the cable glands and corrugated tubes from the lower side of the box.
- Before connecting the power supply, make sure the plate data correspond to those of the mains power supply.
- An omnipolar disconnection switch with a contact opening distance of at least 3mm must be fitted on the mains supply.
- For connection to the mains supply use type H05VV-F cable if routed through conduit, or type H05RN-F if exposed or for outdoors installation.



Make sure to respect the L-N polarity indicated in the mains connection terminal block.

- Check there is an adequate residual current circuit breaker and overcurrent cutout upstream of the electrical system.



The connections to the mains power supply and to any possible low voltage wires (230 V) in the section outside the control panel must be made on an independent channel separated from the connections to the command and safety devices (SELV= Safety Extra Low Voltage). The corrugated tubes must enter the control panel by a few centimetres via the holes on the base box.

- In order to comply with the essential requisites of the Standards in force, reclose the cover once the wires have been connected to the terminals.
- Make sure there are no sharp edges that may damage the cables.
- Make sure the mains power wires (mains, motor, flashing light - 230 V) and the accessory wires (24 V) are separated (Fig. 3.3).
- All the cables must have dual insulation, be sheathed near the relative connection terminals, and be held in place with ties [B] (not supplied).
- If necessary, fit the clip hinges on the bottom of the box and on the cover (left or right side, as preferred) (Fig. 3.4).
- After making the adjustments and settings, fix the cover in place with the screws supplied (Fig. 3.5).

Fig. 3.1

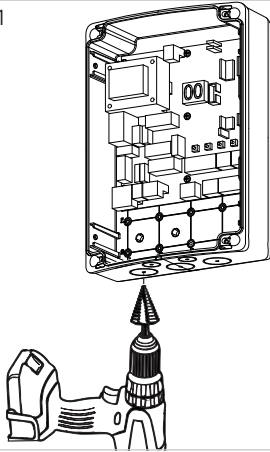

Fig. 3.2

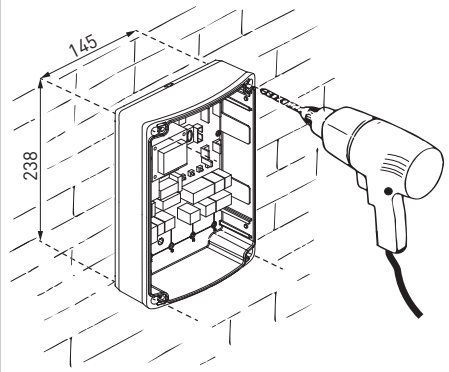

Fig. 3.3

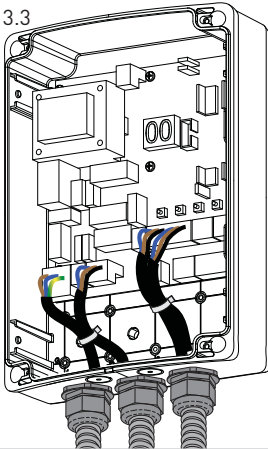

Fig. 3.4

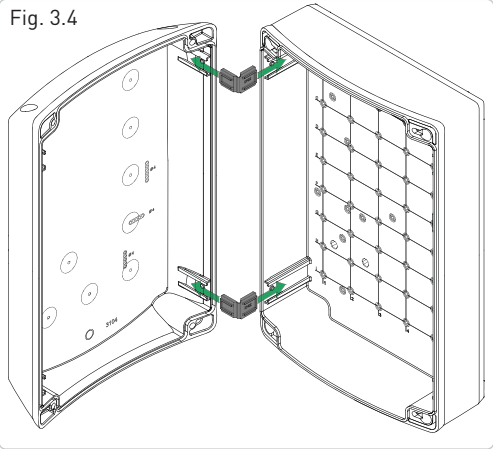
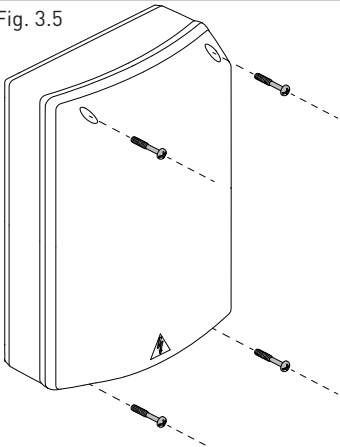
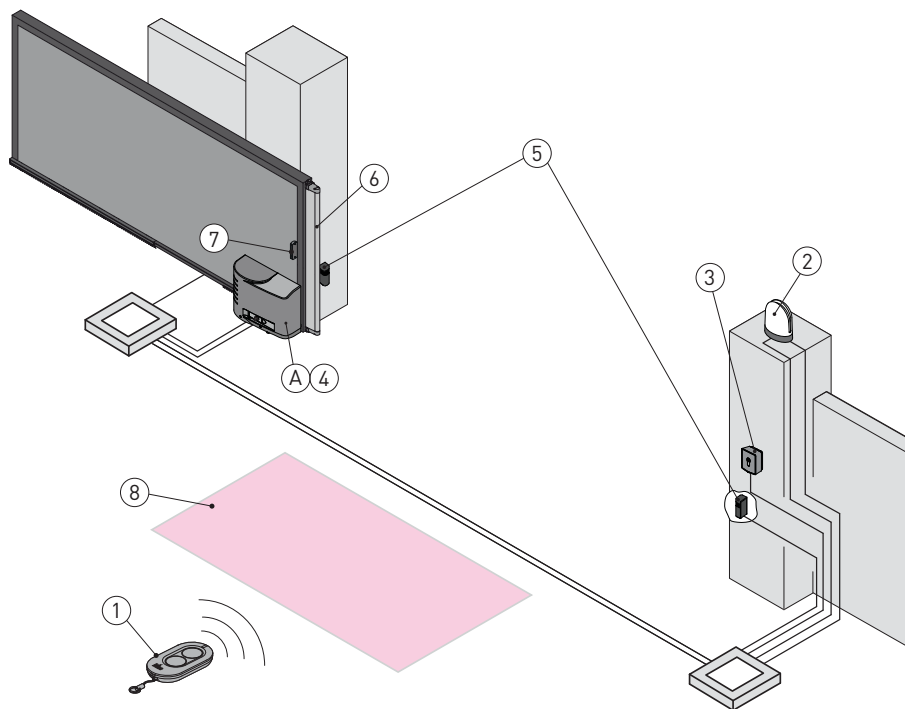

Fig. 3.5



3.1 CROSS installation

3.1.1 Standard installation



Ref.	Code	Description	Cable
1	ZEN	Transmitter	/
2	FLM FL24	Flashing light 230 V	2 x 1 mm ²
		Flashing light 24 V	RG-58 coax cable [50 Ω]
3	AXK5 AXR7 AXK4	Key selector switch	4 x 0.5 mm ²
		Transponder	/
		Digital combination wireless keypad	/
4	CROSS18EP CROSS18VEP	Actuator (motor) 230 V with mechanical limit switch	3G x 1.5 mm ²
		Actuator (motor) 230 V with magnetic limit switch	
A		Connect the power supply to a certified-compliant omnipolar switch (not included) with a contact opening distance of at least 3mm. Connection to the mains must be via an independent conduit, separated from the connections to the command and safety devices.	
5	LIN2 LIN2B AXP2 LAB4	Photocells	4 x 0.5 mm ²
		Photocells	
		Photocells	
		Photocells IP55	
6	SOFAP20 SOF2M20-SOF3M20 SOFA15-SOFA20-SOFA25	Safety edge	2 x 0,5 mm ² min
		Safety edge	
		Safety edge	
7	GOPAV	Radio system for sensitive edges	/
8	LAB9	Magnetic loop detector	2 x 1,5 mm ²

3.1.2 Wiring diagram

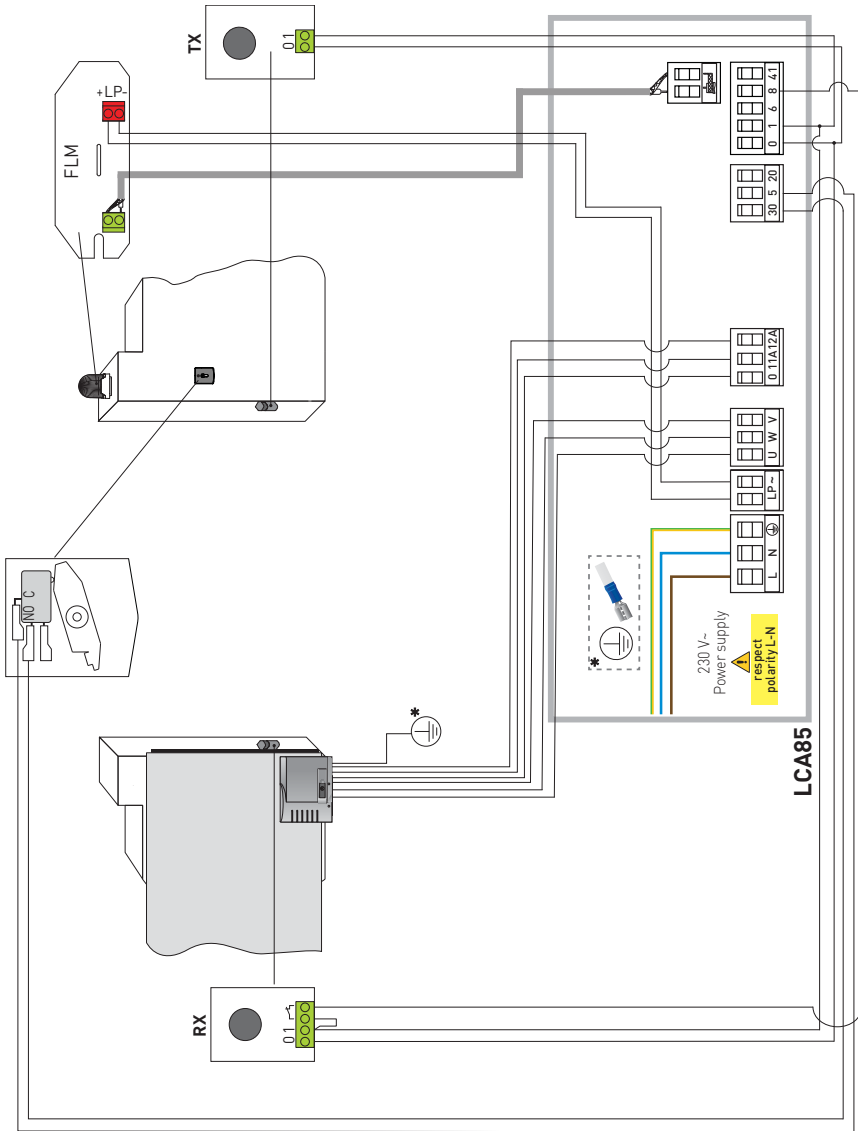

3.2 DOD14 installation on sectional door automations 230 V~

3.2.1 Standard installation

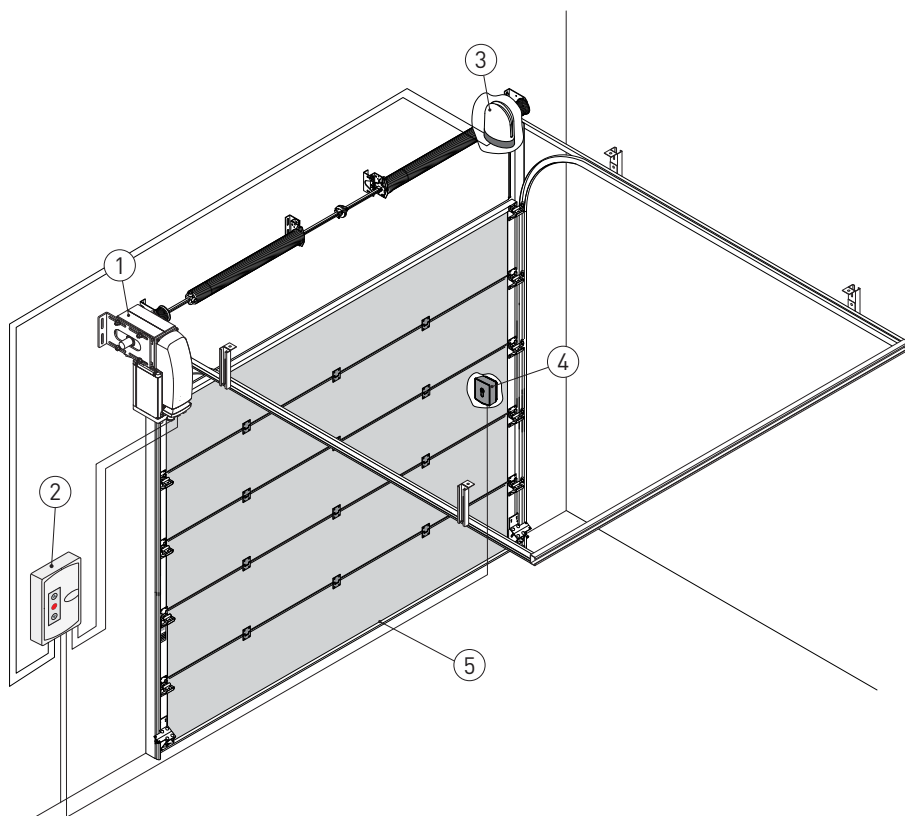

Ref.	Code	Description	Cable
1	DOD14	Actuator (motor)	4 x 1.5 mm ²
		Extra low voltage limit switch unit	3 x 0.5 mm ²
2	LCA85/LCA85B	Control panel	3G x 1.5 mm ²
3	FLM FL24	Flashing light 230 V	2 x 1mm ²
		Flashing light 24 V	
		Antenna (integrated in the flashing light)	RG-58 coax cable (50 Ω)
4	AXK4	Digital combination wireless keypad	/
	AXK5M	Key metal burglar-proof semi-recessed selector switch	4 x 0.5 mm ²
	AXR5I	Key metal burglar-proof wall-mounted selector switch	
	AXK5NM	Key metal burglar-proof wall-mounted selector switch	/
	AXK5NI	Key metal burglar-proof semi-recessed selector switch	/
	AXR7	Transponder	/
5	SOFAP20	Safety edge	
	SOF2M20-SOF3M20	Safety edge	
	SOFA15-SOFA20-SOFA25	Safety edge	
	GOPAV	Safety signal's radio transmission system	/

3.2.2 Wiring diagram

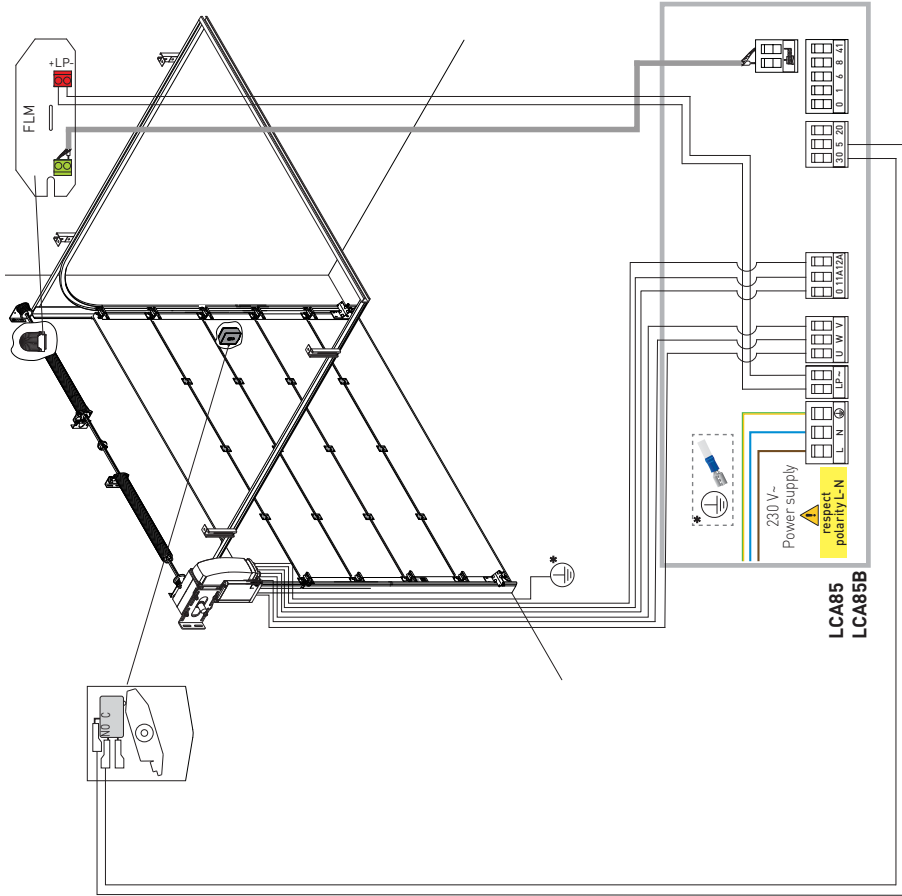

3.3 Standard installation 230 V~ barrier

3.3.1 Ditec QIK4E standard installation wiring diagram

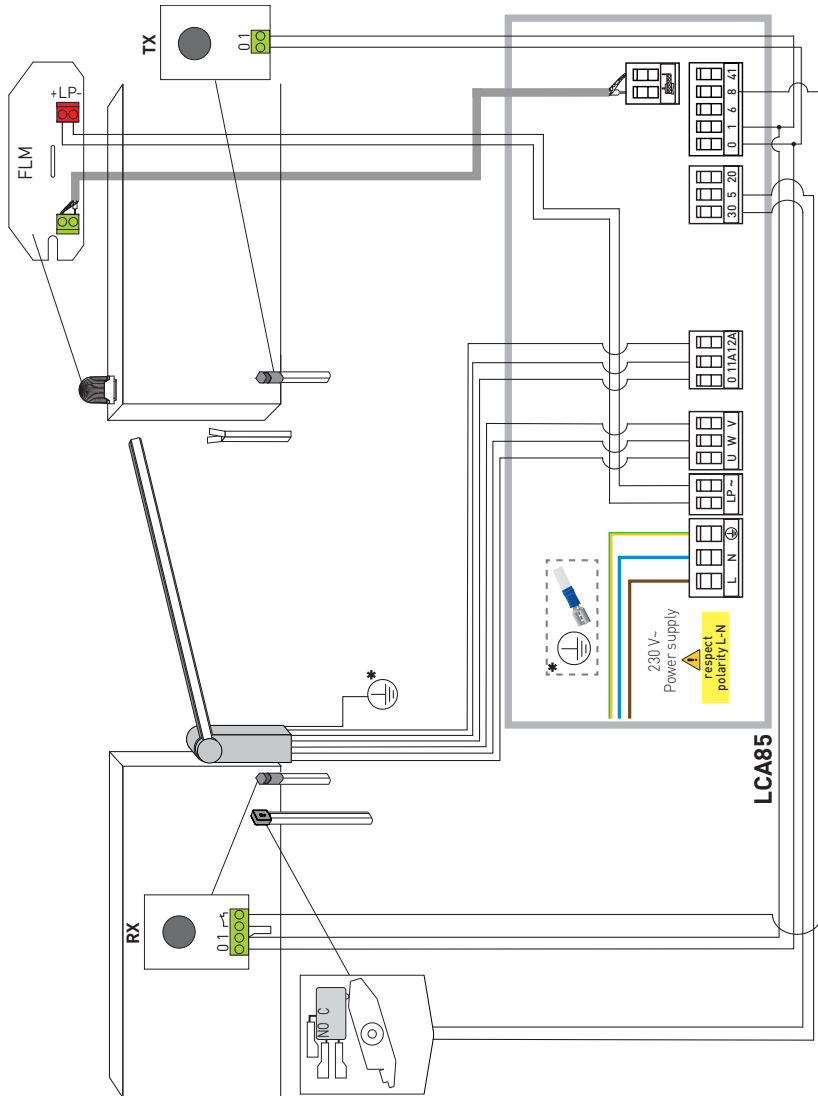

NOTE: Wiring diagram if purchased as spare part for QIK4E.

4. Commands and safety devices



You are advised to read paragraph 11 for all the details about the possible adjustments.



WARNING: terminal 30 (common positive for commands) has the same functions as terminal 1 and for this reason, the commands visible on the display are indicated with 1-5, 1-3, 1-4, etc. However, unlike terminal 1, it is also active when the control panel is in stand by **ES** → **ON**.





WARNING: make a jumper for all NC contacts if not used, or deactivate them via the relative menu. Terminals with the same number are equal.

4.1 Command inputs

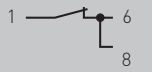

Command	Function	Description
30 2	NO	AUTOMATIC CLOSURE Selecting AC → 1-2 , the permanent closed state of the contact enables automatic closing.
30 3	NO	OPENING When selecting BC → 35 → 1-3 , the closure of the contact activates an opening operation.
	NO	STEP-BY-STEP When selecting BC → 35 → 1-5 , the closure of the contact activates a sequential opening or closing operation: opening-stop-closing-opening. The "opening-stop-closing-opening" sequence can be changed to "opening-stop-closing-stop-opening" by selecting BC → PP .
30 4	NO	CLOSURE Closing of the contact activates a closing operation.
30 5	NO	STEP-BY-STEP When selecting BC → CS → 1-5 , closing the contact starts a sequential opening or closing operation: opening-stop-closing-opening. WARNING: if automatic closure is enabled, the duration of the stop can be defined by selecting BC → SS . The "opening-stop-closing-opening" sequence can be changed to "opening-stop-closing-stop-opening" by selecting BC → PP .
	NO	OPENING When selecting BC → CS → 1-3 , the closure of the contact activates an opening operation.
30 9	NC	STOP The opening of the safety contact causes the current operation to stop. If AP-R9=9P , automatic closure is disabled when contact 30-9 recloses. If AP-R9=9T , automatic closure remains enabled when contact 30-9 recloses.
30 9	NO	"HOLD-TO-RUN" OPERATION When selecting AP → R9 → HR , the opening of contact 30-9 enables the "operator present" function: - opening with operator present 30-3 - closure with operator present 30-4 NOTE: any safety devices, automatic closure and plug-in board in the AUX slot are all disabled.
30 20	NO	PARTIAL OPENING The closure of the contact activates a partial opening operation. Once the automation stops, the partial opening control performs the opposite operation to the one performed before the stop.

4.2 Safety inputs



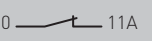

Command	Function	Description
1 6	NC	SAFETY STOP For safety devices with self-test input: When selecting AP → DB → 541 , connect the output contact of the safety device to terminals 1-6 on the control panel (in series with the photocell output contact, if installed).
1 8	NC	REVERSAL SAFETY DEVICE For safety devices with self-test input: When selecting AP → DB → 541 , connect the output contact of the safety device to terminals 1-8 on the control panel (in series with the photocell output contact, if installed).

Command	Function	Description
	NC CLOSING/OPENING SAFETY DEVICE	For safety devices with self-test input: When selecting AP → 6B → 54 , connect the output contact of the safety device to terminals 1-6-8 on the control panel (in series with the photocell output contact, if installed). If 6B → 54 , DB and DB cannot be P4 or 54 .
	R= 8.2kΩ OPENING RESISTIVE SAFETY EDGE	With AP → 6R selected, confirmed by the message NO on the display, a short circuit or open circuit state of the resistance triggers arrest with disengagement and reverses the direction of the automation in accordance with the value set for the parameter 6R .
	R= 8.2kΩ CLOSING RESISTIVE SAFETY EDGE	With AP → 8R selected, confirmed by the message NO on the display, a short circuit or open circuit state of the resistance triggers arrest with disengagement and reverses the direction of the automation in accordance with the value set for the parameter 8R .





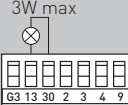
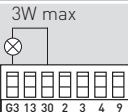



4.3 Limit switch inputs

Command	Function	Description
	NC CLOSING LIMIT SWITCH	Extra low voltage limit switch logic contact. Its behaviour depends on the value set in parameter FC .
	NC OPENING LIMIT SWITCH	Extra low voltage limit switch logic contact. Its behaviour depends on the value set in parameter FA .





5. Outputs and accessories

Output	Value of accessories	Description
	24 V~ 0.3 A max	AC power supply to accessories Output for power supply to external accessories.
	24 V= 0.3 A max	Accessories power supply Output for DC power supply to external accessories.
	24 V= 0.3 A max	Automation status lamp (configurable) For the operating mode of output 30-13, refer to the selection BA → 13 .
	24 V= 0.3 A max	Configurable 24 V= output For the operating mode of output 30-G3, refer to the selection BA → G3 .
AUX 1 AUX 2	GOPAVRS LAB9 BIXPR2 BIXPR2 MOBCRE LAN7S	<p>The control panel has two slots for plug-in command and safety boards. The action of the control board can be selected using BC → AM for AUX1 and BC → AN for AUX2. When using slot-in radio boards, remove the RDX module. The display will show RV.</p> <p> WARNING: the plug-in cards must be inserted and removed with the power supply disconnected.</p> <p> NOTE: the current absorption of the accessories installed in the slots AUX1/AUX2 if associated with output "1" by the relative jumper, must be considered in the total current deliverable by output 1 (0.3 A). Differently if associated to "30" must be considered in the calculation of the total current deliverable by output 30 (0.3 A).</p>

The total sum of the current values delivered by 30,1 and 24 V-outputs must never exceed 0.5 A.

Output	Value of accessories	Description
	ANTENNA	Input for GOL148REA external antenna or rigid wire antenna supplied according to the operating frequency of the receiver module used.
	230 V~ 25 W max	230 V flashing light For connection of a 230 V~ flashing light with auto-flashing function. WARNING: if you want to use the FL24 flashing light (24V~), connect it to output 30-G3 and set parameter G3=01 .
	ZENRS ZENPRS (optional)	For installation of a ZENRS (433.92 MHz) or ZENPRS (868.35 MHz) type radio receiver module. Operation is enabled by selecting BC → RM . When using slot-in radio boards, remove the RDX module. The display will show RV . WARNING: the modules must be inserted and removed with the power supply disconnected
	BIXMR2	COM - Enables saving of operating configurations with function SF → SV . Saved configurations can be recalled with function SF → RC . The storage module allows the remote controls to be stored. If the control panel is replaced, the storage module being used can be inserted in the new control panel. WARNING: the storage module must be inserted and removed with the power supply disconnected, and paying attention to the positioning direction.
	PT3 (optional for LCA85 - included in LCA85B)	 Membrane push-button panel (PT3). Starts the opening operation. NOTE: to activate the closing operation, connect the connector of the push-button panel to J29 (rotated by 180°).  Membrane push-button panel (PT3). Causes the blocking of the movement. See parameter AP → K5  Membrane push-button panel (PT3). Starts the closing operation. NOTE: to activate the opening operation, connect the connector of the push-button panel to J12 (rotated by 180°).
	FUTURE USE	

6. Jumper setting



Jumper	Description	OFF 	ON 
JR1	Display mode selection	Display mode The values and parameters present can be only displayed.	Maintenance mode Maintenance mode. The values and parameters present can be displayed and modified. Activated maintenance mode is indicated by the permanent lit on of the right-hand point on the display.
Jumper	Description	30 1 	30 1 
AUX1	Selection of power supply - auxiliary board 1	AUX1 powered from 0-1	AUX1 powered from 0-30 (default setting)
AUX2	Selection of power supply - auxiliary board 2	AUX2 powered from 0-1	AUX2 powered from 0-30 (default setting)

7. Using menus

i **NOTE:** pressure on the keys may be quick (less than 2s) or prolonged (longer than 2s). Unless specified otherwise, quick pressure is intended. To confirm the setting of a parameter, prolonged pressing is necessary.

7.1 Switching the display ON and OFF

The procedure to switch on the display is as follows: 

- press the key  ;
- the display functioning check starts  ;
- the first level menu is displayed  ;

The procedure to switch off the display is as follows:

- press the key 

NOTE: the display switches off automatically after 60 s of inactivity.

7.2 Navigation keys

- **UP and DOWN keys:** for scrolling through level one or two menus and through the list of possible values for a specific parameter.
- **ENTER key:** accesses the next menu level or the list of possible values for a menu parameter. Press and hold to confirm selection of the currently displayed parameter value.
- **ESC key:** go back to previous step in navigation.
- Simultaneous pressing of the keys **UP** and **ENTER** performs an opening command.

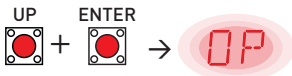

- Simultaneous pressing of the keys **DOWN** and **ENTER** performs a closing command.

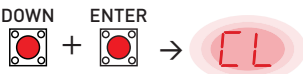

- Simultaneous pressing of the keys **UP** and **DOWN** performs a POWER RESET command. (interruption of the power supply and restart of the automation).



- Hold down the **UP** or **DOWN** key to begin fast menu scrolling.
- In some menus, the parameter measurement unit can be viewed by pressing the ENTER key once the value has been displayed.

Example: setting of 30 seconds for TC parameter.

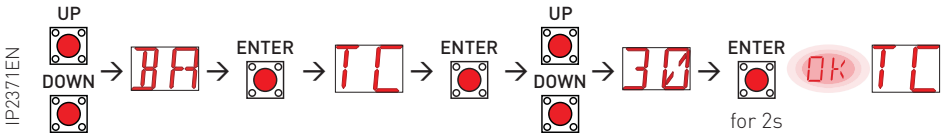

IP2371EN

7.3 Menu map



NOTE: depending on the type of automation and operating mode, some menus may not be available.

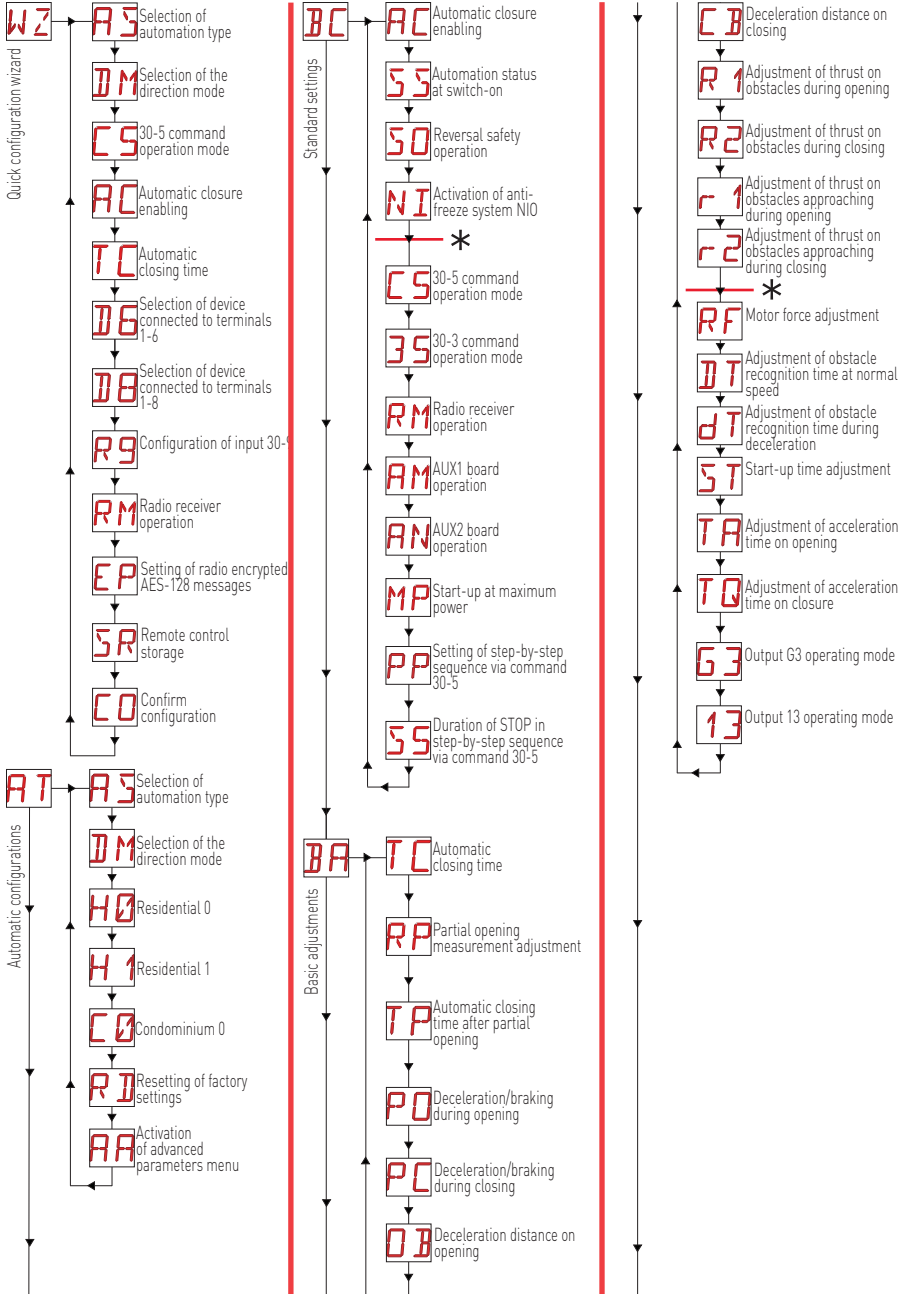

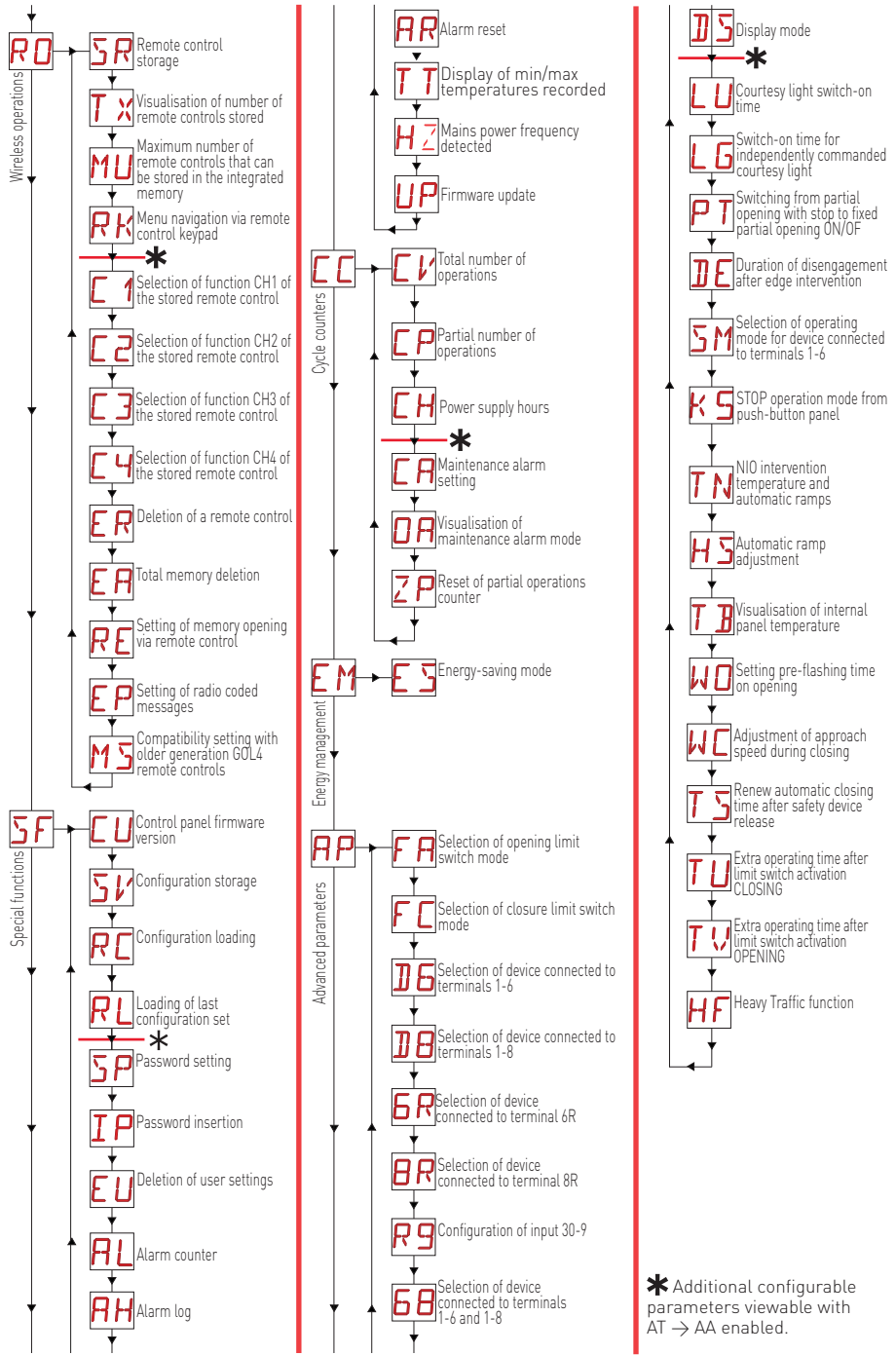

* Additional configurable parameters viewable with AT -> AA enabled.

8. Setting up product for first use

Use the WIZARD (WZ) wizard or the level two AT menu (automatic configuration) to set the product up rapidly with a quick configuration procedure [see parag. 9.2].

For detailed, customised configuration, use the main menus **BC**, **BA**, **RO**, **SF**, **CC**, **EM**, **AP**.

8.1 Wizard configuration menu (WZ)

To access the WZ quick configuration wizard menu:



Hold down the ENTER button for 2 seconds.

Once the message OK stops flashing, the first menu parameter:

WZ →  is displayed for 2 sec. **OK AS**

To set a parameter:

1. Press ENTER to access the configuration items.
2. Scroll UP/DOWN the possible options.
3. To confirm, press the ENTER button for 2 seconds. The selected value flashes and when it has finished, the next parameter appears.

AS →  →  **01** →  for 2 sec. **OK DM**

List of parameters in WIZARD menu:

Display	Description
AS	AS - Motor operating mode <ul style="list-style-type: none"> • 01. Generic automation without deceleration (default) • 02. Sliding gate with deceleration • 03. Barrier with deceleration • 04. Sectional door with deceleration
DM	DM - Selection of the direction mode <ul style="list-style-type: none"> • LF: opening towards left direction (output axis turns clockwise during opening) • RT: opening towards right direction (output axis turns counterclockwise during opening)
CS	C5 - Operation of command associated with contact 30-5 <ul style="list-style-type: none"> • 1-5: step-by-step (default) • 1-3: opening • NO: none • LG: courtesy light
AC	AC - Enabling of automatic closure <ul style="list-style-type: none"> • ON: enabled (default) • OF: disabled • 1-2: dependent on input 1-2 • hR: push-to-operate "dead man" closure (independently of setting of parameter R9) • hr: push-to-operate "dead man" closure, obliged until complete closure (independently of setting of parameter R9) <p>i NOTE: in hr mode if the closure command is removed before reaching the closed position limit switch, the door/gate re-opens automatically.</p>
TC	TC - Setting of automatic closing time [seconds] <p>[NOTE: only viewable visible if AC = ON was selected in previous step]</p> <ul style="list-style-type: none"> • from 0" to 59" with intervals of 1 second. • from 1' (default) to 2' with intervals of 10 seconds.

WZ - Quick configuration wizard

D6	<p>D6 - Selection of device connected to terminals 1-6</p> <ul style="list-style-type: none"> • NO: none. • SE: safety sensing edge (if contact 1-6 opens, 10 cm disengagement is implemented after stop). • S41: safety edge with safety test (if contact 1-6 opens, after the stop there is a disengagement of a duration depending on the selection AP → IE). • PH: photocells. • P41: photocells with safety test.
D8	<p>D8 - Selection of device connected to terminals 1-8</p> <ul style="list-style-type: none"> • NO: none. • SE: safety edge. • S41: safety edge with safety test. • PH: photocells. • P41: photocells with safety test.
R9	<p>R9 - Configuration of input 30-9</p> <ul style="list-style-type: none"> • NO: disabled. • 9P: open state of an input triggers permanent stop (default). • 9T: open state of an input triggers temporary stop. Once contact closes, automatic closure time (if enabled) is activated. • HR: automation operates in "operator present" mode if input is open.
RM	<p>RM - Radio receiver operation</p> <ul style="list-style-type: none"> • 1-3: step-by-step • 1-5: opening (default)
EP	<p>EP - AES (Encrypted Packet) reception setting</p> <p>If the possibility to receive coded messages is enabled, the control panel will be compatible with remote controls of the "AES-128 Encrypted" type.</p> <ul style="list-style-type: none"> • ON: enabled • OF: disabled (default)
SR	<p>SR - Remote control storage</p> <p>When you press ENTER, SR starts to flash and you can associate the desired buttons. Once OK is displayed, SR starts to flash again and you can associate the next button. To quit, press ESC or ENTER for 2 seconds and go on to the next item.</p> <p>NOTE: if NO flashes on the display, the remote control may already be stored.</p>
CO	<p>CO - Save Wizard settings</p> <p>Here you can save the parameters that have previously been set.</p> <ul style="list-style-type: none"> • YS: to save and perform a card RESET • NO: to quit without saving and go back to a blank screen (central part only) <p>NOTE: the message CO and YS/NO sub-menus flash constantly.</p>

To save the configuration:

In the CO parameter select YS (yes) and press the ENTER button for 2 seconds. After saving, a board POWER RESET cycle is performed automatically:

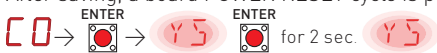

To quit without saving changes:

Select the option NO for the parameter CO and then press and hold ENTER for 2 seconds



Or: from any main parameter, press the ESC button for 2 seconds. Example:

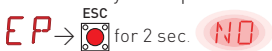

NOTES:

- The set values are only stored on the card if they are saved using the CO parameter.
- The parameter CO and the YS/NO options flash constantly.
- After confirming a configuration parameter, the wizard moves on automatically to the next parameter.
- The UP/DOWN buttons may be used at any time, however, to scroll through parameters.
- There is no time limit for selecting and the wizard will not quit automatically.

8.2 Basic start-up example

8.2.1 Sliding gate





WARNING: the system must have sufficiently robust mechanical end stops



WARNING: if the control panel is used to replace an identical control panel which is faulty, the last automation configuration can be recovered by inserting the old control panel storage module into the new control panel and loading the last set configuration using the menu sequence **SF** → **RL**.



WARNING: before using the automation, make sure that the operating forces of the gate wings comply with the EN 12453:2017 standard and subsequent revisions.

1. Turn on the power.
2. Activate the **WZ** configuration wizard menu. Select the value of parameter **AS** to value **01** for operation without deceleration, or **02** for enabling deceleration phases at the end of opening and closing maneuvers. Set the selections required for the specific installation. Make sure to set the correct opening direction (parameter **DM**).
3. Make a jumper for the safety contacts 1-6, 1-8 and 1-9. If not deactivated via the menu parameters **AP** → **D6**, **AP** → **D8** and **AP** → **R9**.
4. The limit switches must be adjusted so as to take action in proximity of the mechanical stop opening and closing. To adjust the limit switches, refer to the installation manual of the operator in use.
5. Give a closing command ( + ) or wait for the automatic closure to intervene if activated and check that the automation performs the corresponding operation and stops after activating each limit switch (learning operation).
6. Connect the safety devices after removing the jumpers 1-6, 1-8 and 1-9, or reactivating the corresponding inputs using the menu parameters **AP** → **D6**, **AP** → **D8** and **AP** → **R9**. Make sure the various safety devices are operating correctly.



8.2.2 Barrier



WARNING: if the control panel is used to replace an identical control panel which is faulty, the last automation configuration can be recovered by inserting the old control panel storage module into the new control panel and loading the last set configuration using the menu sequence **SF** → **RL**.



WARNING: before using the automation, make sure that the operating forces of the gate wings comply with the EN 12453:2017 standard and subsequent revisions.

1. Turn on the power
2. Activate the **WZ** configuration wizard menu. Select the value of parameter **AS** to value **01** for operation without deceleration, or **03** for enabling deceleration phases at the end of opening and closing maneuvers. Set the selections required for the specific installation. Make sure to set the correct opening direction (parameter **DM**).
3. Make a jumper for the safety contacts 1-6, 1-8 and 1-9. If not deactivated via the menu parameters **AP** → **D6**, **AP** → **D8** and **AP** → **R9**.
4. The limit switches must be adjusted so as to take action in proximity of the mechanical stop opening and closing. To adjust the limit switches, refer to the installation manual of the operator in use.
5. Give a closing command ( + ) or wait for the automatic closure to intervene if activated and check that the automation performs the corresponding operation and stops after activating each limit switch (learning operation).
6. Connect the safety devices after removing the jumpers 1-6, 1-8 and 1-9, or reactivating the corresponding inputs using the menu parameters **AP** → **D6**, **AP** → **D8** and **AP** → **R9**. Make sure the various safety devices are operating correctly.





8.2.3 Sectional door



WARNING: if the control panel is used to replace an identical control panel which is faulty, the last automation configuration can be recovered by inserting the old control panel storage module into the new control panel and loading the last set configuration using the menu sequence **SF** → **RL**.



WARNING: before using the automation, make sure that the operating forces of the gate wings comply with the EN 12453:2017 standard and subsequent revisions.

1. Turn on the power.
2. Activate the **WZ** configuration wizard menu. Select the value of parameter **AS** to value **01** for operation without deceleration, or **04** for enabling deceleration phases at the end of opening and closing maneuvers. Disable automatic closure by setting parameter **AC** to **OF**. Set the other selections required for the specific installation. Make sure to set the correct opening direction (parameter **DM**).
3. Make a jumper for the safety contacts 1-6, 1-8 and 1-9 if not disabled via the menu parameters **AP** → **D6**, **AP** → **D8** and **AP** → **R9**.
4. The limit switches must be adjusted so to take action slightly before reaching the desired opening and closing end positions. To adjust the limit switches, refer to the installation manual of the barrier in use.
5. Perform a complete opening ( +  keys) and closing ( + ) cycle and check that the automation performs the corresponding operation and stops after activating each limit switch (learning operation).
6. By adjusting parameters **AP** → **TU** and **AP** → **TV**, fine-tune the extra operation time after limit switch activation during closing and opening maneuvers respectively, so to reach precisely the desired end position. Some trial-and-error might be required.
7. Enable automatic closure if required (parameter **BC** → **AC**) and adjust the desired automatic closure time delay (parameter **BA** → **TC**).
8. Connect the safety devices after removing the jumpers 1-6, 1-8 and 1-9, or reactivating the corresponding inputs using the menu parameters **AP** → **D6**, **AP** → **D8** and **AP** → **R9**. Make sure the various safety devices are operating correctly.

8.3 Frequently used menu sequences

8.3.1 Enabling the configurations

Step-by-step mode without automatic closure (residential use)

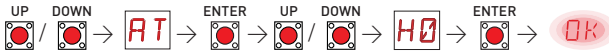

Step-by-step mode with automatic closure 1 min (residential use) [standard settings]

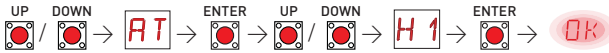

Opening mode with automatic closure 1 min (condominium use)

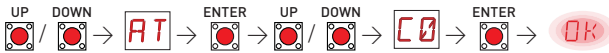

8.3.2 Adding remote controls

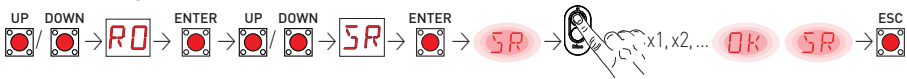

8.3.3 Configuring the NC contact safety devices

Example 1 - Configuring the photocells connected to terminals 1-8 and 1-6 [standard settings]

Set

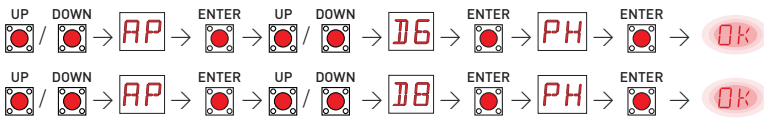

Example 2 - Configuring the safety edge with safety test simultaneously connected to terminals 1-6 and 1-8

Set

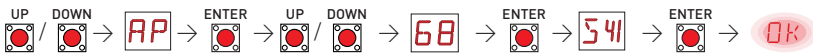

8.3.4 Configuring the resistive safety edges

Example 1 - Configuring the resistive safety edges connected to terminals 1-6R and 1-8R

Set

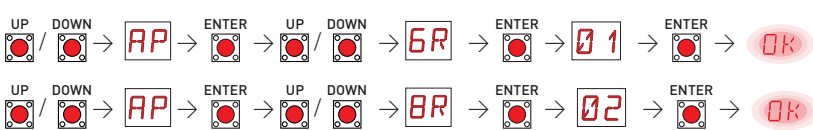

8.4 Synthetic diagram of operation



WARNING: the parameters shown in the figure must be adjusted to comply with exerted forces as outlined in EN 12453.

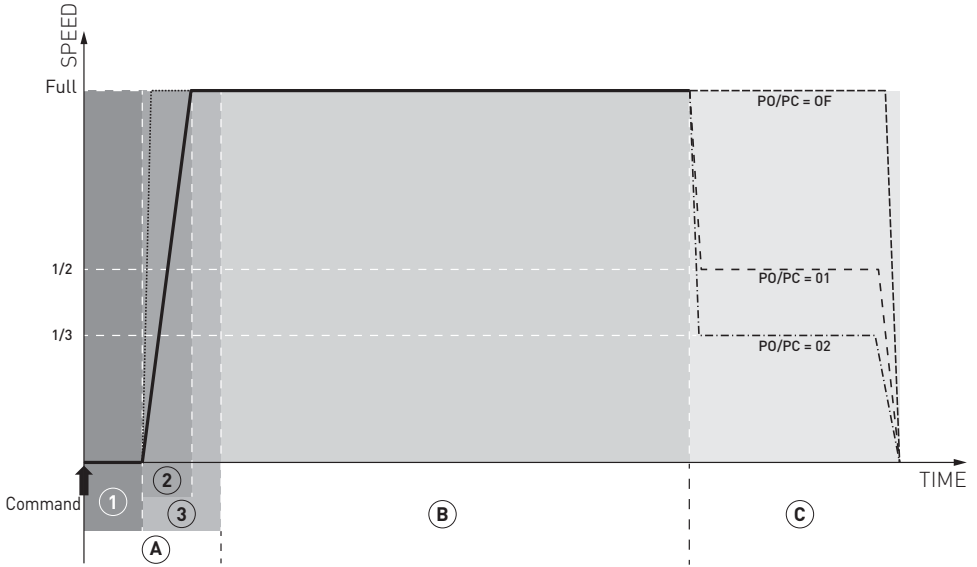

A START-UP PHASE

- 1 **Pre-flashing time:** parameters **W0** (opening) and **WC** (closure)
- 2 **Acceleration time:** acceleration time adjustment - **TA** (opening) and **TQ** (closure)
- 3 **Start time (without detecting obstacles):** start-up at the maximum power **MP** - **ST** (opening and closure)

B FULL SPEED PHASE

- Obstacle detection sensitivity:
- Parameters **R1** (opening) and **R2** (closure).
 - Obstacle detection time: Parameter **DT** (opening and closure)

C FINAL APPROACH PHASE

- Slowdown distance:
- Parameters **OB** (opening) and **CB** (closure).
 - Slowdown speed: Parameters **P0** (opening) and **PC** (closure).
 - Obstacle detection sensitivity: Parameters **r1** (opening) and **r2** (closure)
 - Obstacle detection time: Parameters **dT** (opening and closure)



9. Configuration and settings menu

i **NOTE:** depending on the type of automation and operating mode, some menus may not be available.

9.1 Main menu

Display	Description
WZ	WZ - Quick configuration wizard Quick configuration menu
AT	AT - Automatic Configuration The menu allows you to manage the automatic configurations of the control panel.
BC	BC - Basic Configuration The menu allows you to display and modify the main settings of the control panel.
BA	BA - Basic Adjustments The menu allows you to display and modify the main adjustments of the control panel. i NOTE: some settings require at least three operations before they are set correctly.
RO	RO - Radio Operations The menu is used to manage the radio functions of the control panel.
SF	SF - Special Functions The menu allows you to set the password and manage the special functions in the control panel (alarm management, diagnostics enabling, FW updating).
CC	CC - Cycle Counter The menu allows you to display the number of operations carried out by the automation and manage the maintenance interventions.
EM	EM - Energy Management This menu may be used to view and modify energy saving settings and adjustments (Green Mode).
AP	AP - Advanced Parameters The menu allows you to display and modify the advanced settings and adjustments of the control panel (limit switch mode, selection of devices connected to the terminals, disengagement duration adjustments, flashing light adjustments, etc.). i NOTE: some settings require at least three operations before they are set correctly.

From the main menu you can access the second level menu as follows:



- use the  and  keys to select the required function;
- press  to confirm.

After confirming the selection, you access the second level menu.



For each function of the main menu, there are also additional configurations that can be viewed by enabling the **AA** function (see the following paragraph). The factory settings for the various second level menu parameters are underlined in green.

i **NOTE:** to check if the parameters have actually been modified, quit the relative parameter and then access it again. The modifications will take effect from the next operation.

9.2 Second level menu - AT (Automatic Configuration)

Display	Description										Selections available		
	AS	AS - Motor operating mode - 01. Generic automation without deceleration (default) - 02. <u>Sliding gate with deceleration</u> - 03. <u>Barrier with deceleration</u> - 04. <u>Sectional door with deceleration</u>										0102 0304	
Value		PO	PC	OB	CB	R1	R2	r1	r2	RF	DT	dT	
01		0F	0F	60	60	30	30	30	30	50	40	40	
02		01	01	50	50	20	20	30	30	99	40	60	
03		02	02	15	15	20	20	10	10	70	30	50	
04	01	01	30	30	20	20	30	30	99	40	60		
DM	DM - Selection of the direction mode LF: opening towards left direction (output axis turns clockwise during opening) RT: opening towards right direction (output axis turns counterclockwise during opening)										RTLF (Default value depends on AS setting)		
HO	H0 - Predefined setting, residential use 0, detached house This selection loads predefined values for certain standard parameters: AC - Enable automatic closure : disabled C5 - step-by-step/opening command operation : Step-by-step RM - remote control operation : Step-by-step AM - AUX1 and AUX2 plug-in board operation : Step-by-step SS - Selection of automation status at start-up : open												
H1	H1 - Predefined setting, residential use 1, detached house This selection loads predefined values for certain standard parameters: AC - enabling of automatic closing : enabled TC - setting of automatic closing time : 1 minute C5 - step-by-step/opening command operation : Step-by-step RM - remote control operation : Step-by-step AM - AUX1 and AUX2 plug-in board operation : Step-by-step SS - Selection of automation status at start-up : closed												
CO	C0 - Setting for condominium use Opening and automatic closure at a preset value, with status at start-up closed.												
RD	RD - Resetting of factory settings (SETTINGS RESET) ENTER  → RD → ENTER  → OK												
AAAA	AA - Temporary activation of additional configurable parameters for each main menu function ENTER  → OK → RD										AAAA		
After activation you can scroll through the third level menus. The third level menus are activated for 30min.													

9.3 Second level menu - BC (Basic settings)

BC - Basic settings	Display	Description	Selections available		
	AC	AC - Enabling of automatic closure OF - Disabled ON - Enabled 1-2 - Dependent on input 30-2 hR - Push-to-operate "dead man" closure (independently of setting of parameter R9) hr - Push-to-operate "dead man" closure, obliged until complete closure (independently of setting of parameter R9)	OF	ON	1-2
		 NOTE: in hr mode if the closure command is removed before reaching the closed position limit switch, the door/gate re-opens automatically.	hR	hr	
	SS	SS - Selection of automation status at start-up OP - Open CL - Closed Indicates how the control panel considers the automation at the time of switch-on, or after a POWER RESET command.	OP	CL	
	SO	SO - Enabling of reversal safety contact functioning during opening ON - Enabled OF - Disabled When enabled (ON) with the automation idle, if the contact 1-8 is open, all operations are prevented. When disabled (OF) with the automation idle, if the contact 1-8 is open, opening operations are permitted.		ON	OF
NI	NI - Enabling of NIO electronic anti-freeze system ON - Enabled OF - Disabled When enabled (ON), it maintains the efficiency of the motor even at low ambient temperatures.	 NOTE: for correct operation, the control panel must be exposed to the same ambient temperature as the motors. The intervention temperature for the NIO system can be set by selecting AP → TN .	ON	OF	
	 WARNING: When the NIO system is in operation, the 230 V- (LP-) flashing light output will remain activated. The NIO function cannot be used when motors with limit switches series connected to the phases (FA/FC= MT) are used.				

9.3.1 Additional configurable BC level parameters available with **AT** → **AA** enabled

BC - Basic settings	Display	Description	Selections available	
	CS	C5 - Operation of command associated with contact 30-5 (wakeup from stand-by) 1-3 - Opening 1-5 - Step-by-step LG - Courtesy light command NO - Input 5 disabled	1-3	1-5
	35	35 - Operation of command associated with contact 30-3 1-3 - Opening 1-5 - Step-by-step LG - Courtesy light command NO - Input 3 disabled	1-3	1-5
	RM	RM - Radio receiver operation 1-3 - Opening 1-5 - Step-by-step	1-3	1-5
	AM	AM - Operation of AUX1 plug-in control board 1-3 - Opening 1-5 - Step-by-step NO - Disabled	1-3	1-5
	AN	AM - Operation of AUX2 plug-in control board 1-3 - Opening 1-5 - Step-by-step NO - Disabled	1-3	1-5
	MP	MP - Start-up at maximum power ON - During start-up it increases the thrust to maximum OFF - During start-up, the thrust is the one adjusted by RF .	ON	OFF
	PP	PP - Setting of step-by-step sequence via command 30-5 ON - Opening-Stop-Closing-Stop-Opening OF - Opening-Stop-Closing-Opening	ON	OF
	SS	S5 - Duration of STOP in step-by-step sequence via command 30-5 ON - Permanent (automatic closure is excluded until a new command is given) OF - Temporary (the automatic closure timer intervenes, if enabled)	ON	OF

9.4 Second level menu - BA (Basic adjustments)

NOTE: make adjustments gradually and only after performing at least three complete operations to allow the control panel to be set correctly and detect any friction during operations.

BA	Display	Description	Selections available
	TC	TC - Setting of automatic closing time [s] It is set with different intervals of sensitivity. from 0" to 59" with intervals of 1 second; from 1' to 2' with intervals of 10 seconds.	00 59 11 21 1'00"
RP	RP - Adjustment of partial opening measurement [%] 10 - Minimum 99 - Maximum	10 99 50	

IP2371EN

BA - Basic adjustments

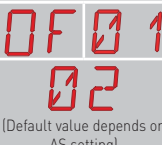
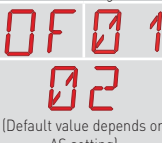
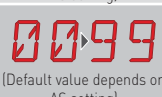
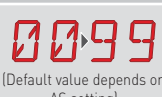
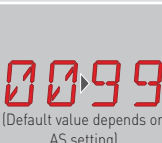
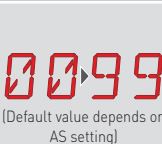
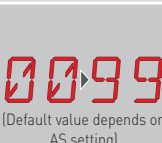
<p>TP</p>	<p>TP - Setting of automatic closing time after partial opening [s] It is set with different intervals of sensitivity. from 0" to 59" with intervals of 1 second; from 1' to 2' with intervals of 10 seconds.</p>	
<p>PO</p>	<p>PO - Deceleration/braking during opening Enables a deceleration phase at the end of the opening stroke 0F - Disabled 01 - Speed 50% 02 - Speed 33%</p>	 <p>(Default value depends on AS setting)</p>
<p>PC</p>	<p>PC - Deceleration/braking during closing Enables a deceleration phase at the end of the closing stroke. 0F - Disabled 01 - Speed 50% 02 - Speed 33%</p>	 <p>(Default value depends on AS setting)</p>
<p>OB</p>	<p>OB - Setting of deceleration/braking distance during opening [cm] Indicates the time between the start of the deceleration ramp and the end of the distance stroke 00 - Minimum 99 - Maximum</p>	 <p>(Default value depends on AS setting)</p>
<p>CB</p>	<p>CB - Setting of deceleration/braking time during closing [cm] Indicates the time between the start of the deceleration ramp and the end of the distance stroke 00 - Minimum 99 - Maximum</p>	 <p>(Default value depends on AS setting)</p>
<p>R1</p>	<p>R1 - Adjustment of thrust on obstacles during normal operation at constant speed when opening. [%] The control panel is fitted with a safety device which, when it detects an obstacle during the opening phase, it stops the movement with a release operation. 00 - Minimum thrust 99 - Maximum thrust</p> <p>i NOTE: if set to 99%, obstacle detection is disabled during opening.</p>	 <p>(Default value depends on AS setting)</p>
<p>R2</p>	<p>R2 - Adjustment of thrust on obstacles during end position approach phase normal movement at constant speed when closing. [%] The control panel is fitted with a safety device which, when it detects an obstacle during closure, it reverses the movement. 00 - Minimum thrust 99 - Maximum thrust</p> <p>i NOTE: if set to 99%, obstacle detection is disabled during closing.</p>	 <p>(Default value depends on AS setting)</p>
<p>r1</p>	<p>r1 - Adjustment of thrust on obstacles during end position approach phase at constant speed when opening. [%] The control panel is fitted with a safety device which, when it detects an obstacle during the approach phase on opening, determined by parameter BA → OB, it implements a release operation. 00 - Minimum thrust 99 - Maximum thrust</p> <p>i NOTE: if set to 99%, obstacle detection is disabled during opening.</p>	 <p>(Default value depends on AS setting)</p>

BA



r2 - Adjustment of thrust on obstacles approaching at constant speed when closing. [%]

The control panel is fitted with a safety device which, when it detects an obstacle during the approach phase on closure, determined by parameter **BA** → **CB**, it reverses the movement.

00 - Minimum thrust

99 - Maximum thrust



NOTE: if set to 99%, obstacle detection is disabled during closing.



(Default value depends on AS setting)

9.4.1 Additional BA level parameters that can be configured (available with

AT → **AA** enabled)

i **NOTE:** make adjustments gradually and only after performing at least three complete operations to allow the control panel to be set correctly and detect any friction during operations.

Display	Description	Selections available
RF	RF - Motor force adjustment. [%] It works throughout the stroke, apart from the start phase, if parameter BA → MP is set to ON.	20 99 (Default value depends on AS setting)
DT	DT - Adjustment of obstacle recognition time at normal speed. [s/100] 20 - Minimum 99 - Maximum	20 99 (Default value depends on AS setting)
dT	dT - Adjustment of obstacle recognition time during deceleration. [s/100] 20 - Minimum 99 - Maximum	20 99 (Default value depends on AS setting)
ST	ST - Adjustment of start time [s] During start-up, obstacle detection is disabled. 2.0 - Minimum 3.0 - Maximum	2.0 3.0 2.0
TA	TA - Adjustment of soft-start time during opening [s] 0.0 - Minimum 1.5 - Maximum i Soft-start function disabled with TA → 00 .	0.0 1.5 0.0
TQ	TQ - Adjustment of soft-start time during closing [s] 0.0 - Minimum 1.5 - Maximum i Soft-start function disabled with TQ → 00 .	0.0 1.5 0.0
G3	G3 - G3 output operating mode See tab. 9.4.1	00 14 ON 00
13	13 - 13 output operating mode See tab. 9.4.1	00 14 ON 03

BA - Basic adjustments

BA - Basic adjustments

Table 9.4.1> Operating modes of configurable outputs 13 and G3 (parameters 13 and G3)





Modalities to the manoeuvring phase		G3-13 output operating mode						
		Entrance closed	Open prelamp	Opening stroke	Open entrance	Closed prelamp	Closing stroke	CB* Entrance closed
00: Courtesy light			☀	LU**	☀			
01: ON-OFF flashing light			☀	☀		☀	☀	
02: Permanent flashing light (auto-flashing)			☀	☀		☀	☀	
03: Proportional indicator light for open gate			☀	☀		☀	☀	
04: Indicator light for open gate			☀	☀		☀	☀	
05: Gate stationary and closed indicator light		☀			☀			☀
06: Gate stationary and fully open indicator light					☀			
07: Gate moving indicator light			☀			☀		
08: Gate opening indicator light			☀			☀		
09: Gate closing indicator light						☀		
10: Red light control / proportional shaft lights		☀	☀	☀		☀	☀	☀
11: Red light flashing control with closed gate/door and proportional input during the operation		☀	☀	☀		☀	☀	☀
12: Electromagnetic lock control - QIKAFE		☀				☀	☀	☀
ON: Output always active								☀
G3-13 special operating mode								
13: STOP signalling / safety switching		☀	☀	☀	☀	☀	☀	☀
14: Maintenance alarm							☀	☀

* CB: Deceleration distance on closing
 ** LU: Courtesy light switch-on time





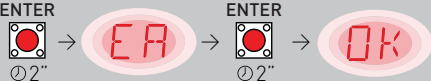









9.5 Second level menu - RO (Radio operations)

RO - Radio operations	SR	<p>Display Description</p> <p>SR - Remote control storage You can directly access the Remote control storage menu even with the display turned off, but only with the Display visualisation mode option set to 00 or 03: - for transmitting a remote control not present in the memory; - for transmitting an unstored channel of a remote control already present in the memory.</p>	
		<p>TX - Visualisation of counter showing remote controls stored ENTER → 00 → 16 → 16 remote controls [example]</p>	
	MU	<p>MU - Indication of maximum number of remote controls that can be stored in the integrated memory You can store a maximum of 100 or 200 remote control codes. ENTER → 10 or 20 → ENTER → OK</p> <p>10 - 100 remote controls that can be stored 20 - 200 remote controls that can be stored</p> <p>WARNING: selecting MU → 20 (200 remote controls), the configurations U 1 and U 2 saved with the SF → SF command will be lost. This also applies for the last configuration reloaded with RL. In addition, new configurations cannot be saved on U 1 and U 2.</p>	<p>Selections available</p> <p>10 <u>20</u></p>
	RK	<p>RK - Menu navigation using remote control keyboard ON - Enabled OF - Disabled With the display turned off, quickly type in the sequence of keys ③ ③ ② ④ ① from the stored remote control you want to use. Make sure all the CH keys are stored.</p> <p>WARNING: during navigation with a remote control keyboard ALL the stored remote controls are inactive.</p> <p>To aid vision and adjustment (avoiding the need to continuously press the remote control), press the UP ↑ or DOWN ↓ key once to begin slowly scrolling through the parameters. This scrolling movement is faster if the UP ↑ or DOWN ↓ key is pressed twice. To stop the scrolling, press ENTER. To confirm your choice of parameter, press ENTER again. To test any new setting, switch off the display and issue an opening command using key ③. Navigation using a remote control keyboard is automatically disabled after 4 minutes of inactivity or by setting RK → OF.</p>	<p>ON <u>OF</u></p>













9.5.1 Additional configurable BO level parameters available with **AT** → **AA** enabled





Display	Description	Selections available
R0 - Radio operations	C1, C2, C3, C4 - Selection of CH1, CH2, CH3, CH4 function of stored remote control NO - No setting selected 1-3 - Opening command 1-4 - Closing command 1-5 - Step-by-step command P3 - Partial opening command LG - Command to switch the courtesy light on/off 1-9 - STOP command If even just one (any) CH key of the remote control is stored, the opening or step-by-step command is implemented.	NO 1-3 1-4 1-5 P3 LG 1-9
	 NOTE: the 1-3 (opening) and 1-5 (step-by-step) options are available as alternatives, and depend on the selection BC → RM .	
	If 2-4 CH keys of a single remote control are stored, the functions matched in the factory with the CH keys are as follows:	
	<ul style="list-style-type: none"> • CH1 = opening/step-by-step command; 1-3 1-5 (depending on parameter RM); • CH2 = partial opening command; P3; • CH3 = command to switch on/off the courtesy light; LG • CH4 = STOP command; 1-9. 	
ER - Deletion of a single remote control 		
EA - Total deletion of the dedicated part of the storage used by remote controls 		
RE - Setting memory opening from remote control OF - Disabled ON - Enabled When enabled (ON), the remote programming is activated. To store new remote controls without using the control panel, refer to the remote control instructions.	ON OF	
EP - Setting coded messages If the possibility to receive coded messages is enabled, the control panel will be compatible with remote controls of the "ENCRYPTED" type.	OF ON	
MS - Backward compatibility setting with older generation GOL4 remote controls. OF - Compatibility with old generation GOL4 and new ZEN remote controls. ON - Compatibility with ZEN series remote controls	OF ON	
 NOTE: MS=ON is recommended if only ZEN series remote controls are used on the system.	ON	

9.6 Second level menu - SF (Special Functions)















Display	Description	Selections available
CU	CU - Displaying the control panel firmware version ENTER  → R. → 1.1 → Release 1.1 [example]	
SV	SV - Saving user configuration on control panel storage module ENTER  → U 1 →  /  → U 2 →  →  [example] ②” By selecting RO → MU → 10 you can save up to 2 personalised configurations in memory positions U 1 and U 2 only with the storage module present on the control panel.  WARNING: if RO → MU → 20 is selected, no user configuration can be saved on U 1 and U 2 .	U 1 U 2
RC	RC - Configuration loading ENTER  → 0 1 →  /  → U 2 →  →  [example] ②” You can load the previously stored user configurations U 1 and U 2 on the memory module of the control panel.	U 1 U 2
RL	RL - Loading of last configuration set ENTER  →  →  ②” the control panel automatically saves the last configuration set, and keeps it memorised in the storage module. In the event of a fault or the replacement of the control panel, the last configuration of the automation can be restored by inserting the storage module and loading the last configuration set.	

9.6.1 Additional configurable SF level parameters available with **AT** → **AA** enabled



























Display	Description
SP	SP - Setting the password ENTER  → 0 1 →  /  → 0 7 →  →  [example] ②”  NOTE: this can only be selected when the password is not set. Setting the password prevents unauthorised personnel from accessing selections and adjustments. You can delete the set password by selecting the sequence JR1=0N, JR1=OFF, JR1=0N.
IP	IP - Inserting the password ENTER  → 0 1 →  /  → 0 7 →  →  [example] ②”  NOTE: this can only be selected when the password is set. When the password is not inserted, you can access the display mode regardless of the selection made with JR1. When the password is inserted, you can access in maintenance mode.

Display	Description
EU	<p>EU - Deletion of user configurations and last configuration set (can be called up from RL)</p> <p>ENTER  → EU → ENTER  → OK</p> <p>⌚ 2"</p>
AL	<p>AL - Alarm counter</p> <p>Used to view, in sequence, the counters of alarms that have been triggered at least once (alarm code + number of times triggered).</p> <p>With UP and DOWN, you can scroll through all the counters and see all the alarms recorded.</p>
AH	<p>AH - Alarm log</p> <p>Used to view, in sequence, alarms that have been triggered (up to a maximum of 20).</p> <p>With UP and DOWN, you can scroll through the entire alarm log.</p> <p>The display shows the alarm number and code, alternated.</p> <p>The highest number corresponds to the most recent alarm and the lowest number (0) corresponds to the oldest alarm.</p>
AR	<p>AR - Alarm reset</p> <p>Resets all the alarms in the memory (counters and log).</p> <p>ENTER  → OK</p> <p>⌚ 2"</p> <p>i NOTE: when the installation has been completed, you are advised to delete the alarms in order to facilitate future checks.</p>
TT	<p>TT - Display of min/max temperatures recorded</p> <ul style="list-style-type: none"> - press for 2 sec to reset the values; - minimum value with active right decimal point.
HZ	<p>HZ - Mains power frequency detected (Hz)</p> <ul style="list-style-type: none"> - FF displayed after power-on of control panel. - the real measured value will be shown once the first movement has begun, and will be updated with every subsequent operation. - resolution is 1 Hz.
UP	<p>UP - Firmware update</p> <p>Activates the card bootloader in order to update the firmware.</p> <p>ENTER  → OK</p> <p>⌚ 2"</p>





9.7 Second level menu - CC (Cycles Counter)

Display	Description
	CV - Display of total operations counter ENTER  →  →  →  → 182 operations [example]
	CP - Display of partial operations counter ENTER  →  →  →  → 716 operations [example]
	CH - Display of power supply hour counter ENTER  →  →  →  → 215 operating hours [example]

9.7.1 Additional configurable CC level parameters available with **AT** → **AA** enabled

Display	Description	Selections available
	CA - Setting the maintenance alarm (factory setting - alarm deactivated: 0.0 00. 00) You can set the required number of operations (regarding the partial operations counter) for signalling the maintenance alarm. When the set number of operations is reached, the alarm message appears on the display  . Example: Setting the maintenance alarm after 700 operations (00) (07) (00) ENTER  →  → UP  / DOWN  →  → ENTER  →  → UP  / DOWN  →  → ENTER  →  → ENTER  → 	
	OA - Selecting maintenance alarm display mode 00 - Visualisation on display (alarm message  01 - Visualisation on flashing light (with the automation idle, 4 flashes are made and then repeated every hour) and on display (alarm message  02 - Visualisation on "open gate" indicator light (with the automation closed, 4 flashes are made and then repeated every hour) and on display (alarm message ).	  
	ZP - Reset of partial operations counter ENTER  →  02" <p>For correct functioning, you are advised to reset the partial operations counter:</p> <ul style="list-style-type: none"> - after maintenance work; - after setting the maintenance alarm interval. 	

9.8 Second level menu - EM (Energy management)

Display	Description	Selections available
	ES - "Green Mode" (energy-saving) (disconnection of accessories connected to terminals 0-1 when the automation is in standby) ON - Enabled (the red point on the right of the display flashes every 5 s. Outputs LP-, 30-13 and 30-63 are not affected by the low-consumption mode). OF - Disabled. Power supply disconnection mode is activated after 15 s with the gate closed, or when the gate is idle and automatic closure is not enabled. The automation resumes normal operation when a command is received from the radio board (ZENRS-ZENPRS) or after a contact 30-5, 30-20, 30-3 or 30-4.	 
	WARNING: if you use accessories that need to remain powered even with Green Mode enabled [e.g. LAB9 or GOPAVRS], set the jumper AUX1-2 relating to the slot used on power supply 0-30.	

9.9 Second level menu - AP (Advanced parameters)

Display	Description	Selections available	
FA	FA - Opening limit switch mode SX: stop limit switch MT: stop limit switch series connected to the motor phase	SX	MT
FC	FC - Closing limit switch mode SX: stop limit switch MT: stop limit switch series connected to the motor phase	SX	MT
D6	D6 - Selection of device connected to terminals 1-6 NO - None SE - Safety sensing edge (if contact 1-6 opens, 10 cm disengagement is implemented after stop). S41 - Safety edge with safety test (if contact 1-6 opens, after the stop there is a disengagement of a duration depending on the selection AP → DE) PH - Photocells P41 - Photocells with safety test	NO S41 P41	SE PH
D8	D8 - Selection of device connected to terminals 1-8 NO - None SE - Safety edge S41 - Safety edge with safety test PH - Photocells P41 - Photocells with safety test	NO S41 P41	SE PH
6R	6R - Device connected to terminal 6R NO - None 01 - Stop with disengagement during both opening and closing operations. [Once the idle resistance value (8.2K) has been reset, operation is resumed]. 02 - During closure, a significant variation in the resistance value above or below the idle resistance value (8.2K) stops and reverses movement. When the automation is stationary, all operations are disabled.	NO 01	02
8R	8R - Device connected to terminal 8R NO - None 01 - Stop with disengagement during both opening and closing operations. [Once the idle resistance value (8.2K) has been reset, operation is resumed]. 02 - During closure, a significant variation in the resistance value above or below the idle resistance value (8.2K) stops and reverses movement. When the automation is stationary, all operations are disabled.	NO 01	02
R9	R9 - Configuration of input 30-9 NO - Disabled 9P - Open state of an input triggers permanent stop. 9T - Open state of an input triggers temporary stop. Once contact closes, automatic closure time (if enabled) is activated. HR - Automation operates in "operator present" mode if input is open	NO 9P 9T	9T 9P HR
68	68 - Selection of the device simultaneously connected to terminals 1-6 and 1-8 NO - None SE - Safety edge S41 - Safety edge with safety test If different from NO, the simultaneous opening of inputs 1-6 and 1-8 causes: - movement stop and reversal during a closing operation. - movement stop and disengagement of a duration depending on the selection AP → DE during an opening operation.	NO SE S41	
D5	D5 - Setting of display visualisation mode without alarm 00 - No information displayed. 01 - Countdown to automatic closure displayed. 02 - Automation status (see paragraph 13.1). 03 - Commands and safety devices (see paragraph 13.2).	00 01 02	02 03
	 NOTE: the setting 01 allows you to see when a radio transmission is received, for range checks.		

AP - Advanced parameters

9.9.1 Additional configurable AP level parameters available with **AT** → **AA** enabled

i **NOTE:** make adjustments gradually and only after performing at least three complete operations to allow the control panel to be set correctly and detect any friction during operations.

Display	Description	Selections available
AP - Advanced parameters LU	LU - Setting switch-on time for courtesy light [s] To enable this parameter, set at least one of the selections BA → 13 or BA → G3 as a courtesy light. It is set with different intervals of sensitivity. NO - Disabled - from 01" to 59" with intervals of 1 second - from 1' to 2' with intervals of 10 seconds - from 2' to 3' with intervals of 1 minute ON - Permanently enabled (switched off via remote control)	
	i NOTE: the courtesy light switches on at the start of each operation.	
	LG - Switch-on time for independently commanded courtesy light [s] To enable this parameter, set at least one of the selections BA → 13 or BA → G3 as a courtesy light. It is set with different intervals of sensitivity. NO - Disabled - from 01" to 59" with intervals of 1 second - from 1' to 2' with intervals of 10 seconds - from 2' to 3' with intervals of 1 minute ON - Switched on and off with remote control	
	i NOTE: the switching on of the light does not depend on the start of an operation, but can be commanded separately using the special remote control key.	
PT	PT - Fixed partial opening ON - Enabled OF - Disabled If ON, a partial opening command given on the partial opening position is ignored. With contact 30-20 closed (for example with the timer or manual selector), the gate will partially open. If it is then fully opened (command 30-3) and reclosed (even with automatic closing), it will stop at the partial opening position.	
DE	DE - Disengagement duration if an edge is triggered [s] Regulates the duration of the disengagement when an edge (active) is triggered during opening or closure. 00 - Disable.	

AP - Advanced parameters

SM	<p>SM - Selection of operating mode of device connected to terminals 1-6</p> <p>00 - During an opening or closing manoeuvre, the opening of I-6 safety contact stops the movement. When the contact is closed again the interrupted manoeuvre does not resume, and the operator waits for an external command or performs an automatic closure if enabled.</p> <p>01 - During an opening or closing manoeuvre, the opening of I-6 safety contact stops movement. When the contact is closed again the interrupted manoeuvre is resumed.</p> <p>02 - During an opening or closing manoeuvre, the opening of I-6 safety contact stops the movement. When the contact is closed again a total opening manoeuvre is performed.</p> <p>03 - During a closing manoeuvre, the opening of I-6 safety contact reverses the movement. During the opening manoeuvre, the behaviour of safety contact I-6 has no effect</p> <p>04 - During an opening manoeuvre, the opening of I-6 safety contact stops the movement. When the contact is closed again, the interrupted opening manoeuvre is resumed. During the closing manoeuvre, the behaviour of safety contact I-6 has no effect</p> <p>05 - During a closing manoeuvre, the opening of I-6 safety contact stops the movement. If I-6 contact is closed again within 1 second, a total opening manoeuvre is performed. Contrariwise, if it is closed again later, no further opening manoeuvre is performed and the operator waits for and external command or for an automatic closure if enabled. During an opening manoeuvre, the opening of I-6 safety contact stops the movement. When the contact is closed again the interrupted manoeuvre is not resumed, and the operator waits for and external command or performs an automatic closure if enabled.</p> <p>06 - Guillotine function - no effect during the opening manoeuvre. During the closing manoeuvre it causes a STOP and once contact I-6 is closed again, closing proceeds after 1 second. When the entrance is closed it prevents any movement.</p> <p>i NOTE: in all the cases described above, after a movement stop event a disengagement is performed if I6 → SE/54.</p>	<p>00 01</p> <p>02 03</p> <p>04 05</p> <p>06</p>
KS	<p>KS - STOP operation mode by push-button panel (with optional PT3 push-button panel)</p> <p>P9 - A short press of STOP button stops the operation in progress. An intentional opening, even partial opening, closing or step-by-step command takes the door out of the STOP condition and is executed normally.</p> <p>T9 - A short press of STOP button stops the operation in progress and prevents any further action, until a new short press of the STOP button, which returns to normal operating condition and allows the operation of automatic closing timer if active.</p> <p>B9 - A short press of STOP button stops the operation in progress and avoids any further action, up to a new STOP button pressing, which returns to normal operating condition but disables automatic closing (if enabled), until a new intentional opening (even partial), closing or step-by-step command.</p>	<p>P9 T9</p> <p>B9</p>
TN	<p>TN - Setting of intervention temperature for the NIO electronic anti-freeze system and automatic HS ramps [°C]</p> <p>This value does not refer to the ambient temperature, but to the internal control panel temperature.</p> <p>i NOTE: With TT parameter the highest/lowest temperature reached by the control unit can be checked.</p>	<p>-- 950</p> <p>10</p>
HS	<p>HS - Automatic ramp adjustment</p> <p>ON - Enabled</p> <p>OF - Disabled</p> <p>When enabled (ON), at low ambient temperatures the start time ST increases up to the maximum value and the acceleration time TA and TB diminishes to the minimum value.</p> <p>i NOTE: not active if FC → SX.</p> <p>The activation temperature is settable by selecting AP → TN.</p>	<p>ON OF</p>

AP - Advanced parameters

TB	<p>TB - Permanent display of the internal control panel temperature [°C]</p> <p>ON OF</p>	
WO	<p>WO - Setting of pre-flashing time on opening [s]</p> <p>Adjustment of the lead time for the switch-on of the flashing light, in relation to the start of the opening operation from a voluntary command.</p> <p>00 - Minimum 05 - Maximum.</p>	
WC	<p>WC - Setting of pre-flashing time on closing [s]</p> <p>Adjustment of the lead time for the switch-on of the flashing light, in relation to the start of the closing operation from a voluntary command.</p> <p>00 - Minimum 05 - Maximum.</p>	
TS	<p>TS - Setting of renewal of automatic closing time after safety device release [%]</p> <p>00 - Minimum 99 - Maximum.</p>	
TV	<p>TV - Extra operating time after limit switch activation OPENING</p> <p>Sets an additional maneuver time after activation of OPENING limit switch, in order to do a fine tuning of the end position.</p> <p>Range: 0.0 to 9.99 seconds, in 0.05 seconds increments. The dot after the second digit indicates half tenth of second (example: 3.5 seconds → display 3.5; 3.55 seconds → display 3.5).</p>	
TU	<p>TU - Extra operating time after limit switch activation CLOSING</p> <p>Sets an additional maneuver time after activation of CLOSING limit switch, in order to do a fine tuning of the end position.</p> <p>Range: 0.0 to 9.99 seconds, in 0.05 seconds increments. The dot after the second digit indicates half tenth of second (example: 3.5 seconds → display 3.5; 3.55 seconds → display 3.5).</p>	
HF	<p>HF - Heavy Traffic function</p> <p>ON - Enabled OF - Disabled</p> <p>When this function is enabled, the automatic reclosing time is increased automatically to 3 min in the event of a series of consecutive operations due to frequent aperture requests (e.g. at peak traffic times in a condominium application), to reduce wait times for users and to limit motor wear and the risk of overheating.</p>	

10. Diagnostics



10.1 Data Logging integrated in the board

The Ditec LCA85 control panel is equipped with an internal system which allows the installer to check whether any alarms have been triggered, see how many times each alarm has been triggered and view a the log of the last twenty alarms.

10.1.1 Alarm counter

With the third level menus enabled (**AT** → **AA**), go to **SF** → **AL** to see all the alarms recorded by the control panel. The display alternately shows the alarm code and the number of times it was triggered.



Example: **00** **05** **00** **05** ...

Use the  and  keys to scroll through the entire list of alarm counters.

10.1.2 Alarm log

With the third level menus enabled (**AT** → **AA**), go to **SF** → **AH** to see the alarm log (the last 20 alarms recorded). The display shows the alarm number and code, alternated. The highest number corresponds to the most recent alarm and the lowest number corresponds to the oldest alarm.

Example: **-1** **00** **-1** **00** ...

Use  and  to scroll through the alarm log.









11. Signals visualised on the display

i **NOTE:** depending on the type of automation and control panel, certain visualisations may not be available.

11.1 Display of automation status

i **NOTE:** the automation status display mode is only visible with Display visualisation mode set to 02.

AP ▶ **DS** ▶ **02**

Display	Description	Display	Description
	Automation closed		Automation opening
	Automation open		Automation closing, from partial opening
	Automation stopped in intermediate position		Automation in partial opening
	Automation closing		Automation partially open

11.2 Display of safety devices and commands

i **NOTE:** the safety device and command display mode is only visible with Display visualisation mode set at 01 or 03.

AP → JS → 01 AP → JS → 03



Display	Description	Display	Description
1-2	1-2 - Automatic closure enable command.	CX	CX - Command received from AUX1 board
1-3	1-3 - Opening command.	CY	CY - Command received from AUX2 board
1-4	1-4 - Closure command.	FC	FC - Closure limit switch
1-5	1-5 - Step-by-step command.	FA	FA - Opening limit switch
1-6	1-6 - Safety device with opening and closing stop.	S1	S1 - Stop detection during closure operation
1-8	1-8 - Safety device with reversal during closing operation.	S2	S2 - Stop detection during aperture operation
1-9	1-9 - STOP command.	00	00 - Obstacle detection limit reached during aperture operation
6R	1-6R - Activation or malfunction of aperture operation stop resistive sensing edge	0C	0C - Obstacle detection limit reached during closure operation
8R	1-8R - Activation or malfunction of closure reversal resistive sensing edge	RV	RV - Enable/disable built-in radio receiver via RDX.
68	68 - Device connected simultaneously to terminals 1-6 and 1-8.	MQ	MQ - Mechanical end stop learning operation in progress.
P3	P3 - Partial opening command.	HT	HT - Motor heating (NIO function) in progress.
3P	3P - Opening command with operator present	J1	JR1 - Change in jumper JR1 status.
4P	4P - Closing command with operator present	PC	PC - Connected HOST (Personal Computer) recognised.
RX	RX - Radio reception (from any memorised key of a transmitter stored in memory)	ES	ES - Switch to Green Mode (energy-saving)
NX	NX - Radio reception (from any non-memorised key) NOTE: with the selection AP → JS → 01, it is also visualised when a command is received from a non-stored transmitter.	1C	1C - Closing operation
EX	EX - Rolling-code radio reception out of sequence	LG	LG - Courtesy light/garden light command
EP	EP - Radio reception not compliant with parameter configuration RO → EP		

11.3 Visualisation of alarms and faults



WARNING: the visualisation of alarms and faults is possible with any visualisation selection. The signalling of alarm messages takes priority over all other displays.

Type of alarm	Display	Description	Operation
Type of alarm	M3	M3 - Motor blocked or limit switch not released within 3 s	Check if there are any obstacles and make sure the gate moves smoothly and the limit switch works properly
	M6	M6 - Overrun limit switch opens	
	M7	M7 - Overrun limit switch closes	
	M8	M8 - Limit switch not found	
	MB	MB - Motor not detected during operation.	
	MI	MI - Detection of fifth consecutive obstacle	Check for the presence of permanent obstacles along the stroke of the automation. Check the settings / operating of any limit switches.
	ML	ML - Inverted motor stop limit switches	Repair the motor 1 limit switch connection
	MN	MN - Inverted motor stop limit switches	Limit switches not found during starting operation
	OD	OD - Obstacle on wing detected during aperture.	Check for the presence of obstacles along the automation stroke.
	OE	OE - Obstacle on wing detected during closure.	Check for the presence of obstacles along the automation stroke.
Settings alarm	S6	S6 - Incorrect setting of safety device test	Check the configuration of parameters D6 , D8 , 68 . If 68 → S41 , D6 and D8 cannot be P41 or S41 .
Service alarm	V0	V0 - Maintenance request.	Proceed with the scheduled maintenance intervention.

Type of alarm	Display	Description	Operation
Internal control panel alarm	I5	I5 - No voltage 0-30 (faulty voltage regulator or short-circuit on accessories)	Check there is no short circuit in connection 0-30. If the problem persists, replace the control panel.
	I6	I6 - Excessive voltage 0-30 (faulty voltage regulator)	Replace the control panel.
	I7	I7 - Internal parameter error - value outside limits	Reset. If the problem persists, replace the control panel.
	I8	I8 - Program sequence error	Reset. If the problem persists, replace the control panel.
	IA	IA - Internal parameter error (EEPROM/FLASH)	Reset. If the problem persists, replace the control panel.
	IB	IB - Internal parameter error (RAM)	Reset. If the problem persists, replace the control panel.
	IC	IC - Operation time out error (>3 min).	Manually check that the gate wing moves freely. If the problem persists, replace the control panel.
	IE	IE - Power supply circuit fault	Reset. If the problem persists, replace the control panel.
	IM	IM - TRIAC alarm - motor 1 short circuited or always ON.	Reset. Check the settings / operating of any limit switches. If the problem persists, replace the control panel.
	IU	IU - Motor voltage reading circuit test error.	Reset. If the problem persists, replace the control panel.
	XX	XX - Firmware reset commanded by simultaneous usage	 +  keys
	WD	WD - Firmware reset not commanded	
Radio operations alarm	R0	R0 - Storage module installed containing over 100 stored remote controls. WARNING: the R0 → MU → 20 setting is made automatically.	To save the system configurations on the storage module, delete any stored remote controls and bring the total to less than 100. Set R0 → MU → 10 .
	R3	R3 - Storage module not detected	Insert a storage module.
	R4	R4 - Storage module not compatible with the control panel	Insert a compatible storage module.
	R5	R5 - No serial communication with the storage module	Replace the storage module.
	R6	R6 - Specific storage module for testing installed.	
Power supply alarm	P1	P1 - Microcontroller voltage too low.	Check the control panel is powered correctly.
	HZ	HZ - Mains power frequency not within acceptable range (< 45 Hz or > 65 Hz)	Checks the quality of the mains electrical power supply

Type of alarm	Display	Description	Operation
Accessories alarm	A0	A0 - Test of safety sensor on contact 6 failed.	Check the safety device is working properly. If the supplementary safety board is not inserted, check the safety test is disabled.
	A1	A1 - Test of safety sensor connected simultaneously to contacts 6 and 8 failed.	Check the wiring and correct operation of the safety sensor.
	A3	A3 - Test of safety sensor on contact 8 failed.	Check the safety device is working properly. If the supplementary safety board is not inserted, check the safety test is disabled.
	A5	A5 - Test failed: safety sensor on contact 6R.	
	A6	A6 - Test failed: safety sensor on contact 8R.	
	A7	A7 - Incorrect connection of contact 9 to terminal 41	Check that terminal 41 and 9 are correctly connected.
	A9	A9 - Overload on output 30-G3.	Check the device connected to output 30-G3 is working properly.
	AB	AB - Overload on output 30-13	Check the device connected to output 30-13 is working properly.

12. Troubleshooting

Problem	Possible cause	Alarm signaling	Operation	
The control panel does not switch on	No power supply.		Check the power supply cable and the F1 fuse.	
	Internal fault		Contact Technical Service	
The automation does not open or close	No power.		Check the power supply cable and the F1 fuse.	
	Short circuited accessories.	I5	Disconnect all accessories from terminals 0-1 or 0-30 (a voltage of 24 V _{DC} must be present) and reconnect them one at a time. Contact Technical Support Service	
	Blown line fuse.		Replace fuse F1.	
	Safety contacts are open.	I-6 68	I-8	Check that the safety contacts are closed correctly (NC).
	Safety contacts not correctly connected or self-controlled safety edge not functioning correctly.	A0 A1 A3	I-6 I-8 68	Check connections to terminals 6-8 on control panel and connections to the self-controlled safety edge.
	Photocells activated.	I-6	I-8	Check that the photocells are clean and operating correctly.
	The safety edges connected to 6R and 8R are pressed or blocked	6R	8R	Check the resistance values of the safety edges.
	The automatic closure does not work.			Issue any command. If the problem persists, contact Technical Service
	Faulty motor or tripping of thermal switch.		M8	Check motor connection, if the problem persists, contact Technical Service.

Problem	Possible cause	Alarm signaling	Operation
External safety devices not activating	Incorrect connections between the photocells and the control panel.		Check that I-6 / I-8 is displayed Connect NC safety contacts together in series and remove any jumpers on the control panel terminal board. Check the AP → J6 and AP → J8 setting
The automation opens/closes briefly and then stops.	There is a presence of friction.	MI DI DE	Manually check that the automation moves freely and check the R 1 / R 2 adjustment. Check that the limit switches, if installed, are working correctly Contact Technical Service
The remote control has limited range and does not work with the automation moving.	The radio transmission is impeded by metal structures and reinforced concrete walls.		Install the antenna outside. Replace the transmitter batteries.
The remote control does not work	No storage module or incorrect storage module.	R0 R3 R5	Switch the automation off and plug in the correct storage module. Check the correct memorisation of the transmitters on the built-in radio. If there is a fault with the radio receiver that is built into the control panel, the remote control codes can be read by removing the storage module.



13. Maintenance

The control panel doesn't require any special maintenance.

Make regular checks to ensure the seals on the box and the electrical connections are in good condition.

All the rights concerning this material are the exclusive property of ASSA ABLOY Entrance Systems AB. Although the contents of this publication have been drawn up with the greatest care, ASSA ABLOY Entrance Systems AB cannot be held responsible in any way for any damage caused by mistakes or omissions in this publication. We reserve the right to make changes without prior notice.

Copying, scanning or changing in any way is expressly forbidden unless authorised in writing by ASSA ABLOY Entrance Systems AB.

 The crossed-out wheelee bin symbol indicates that the product should be disposed of separately from normal household waste. The product should be recycled in accordance with local environmental regulations  for waste disposal. By separating a product marked with this symbol from household waste, you will help reduce the volume of waste sent to incinerators or land-fill and minimise any potential negative impact on human health and the environment.

